

Art. Nr. 2848296

1/7







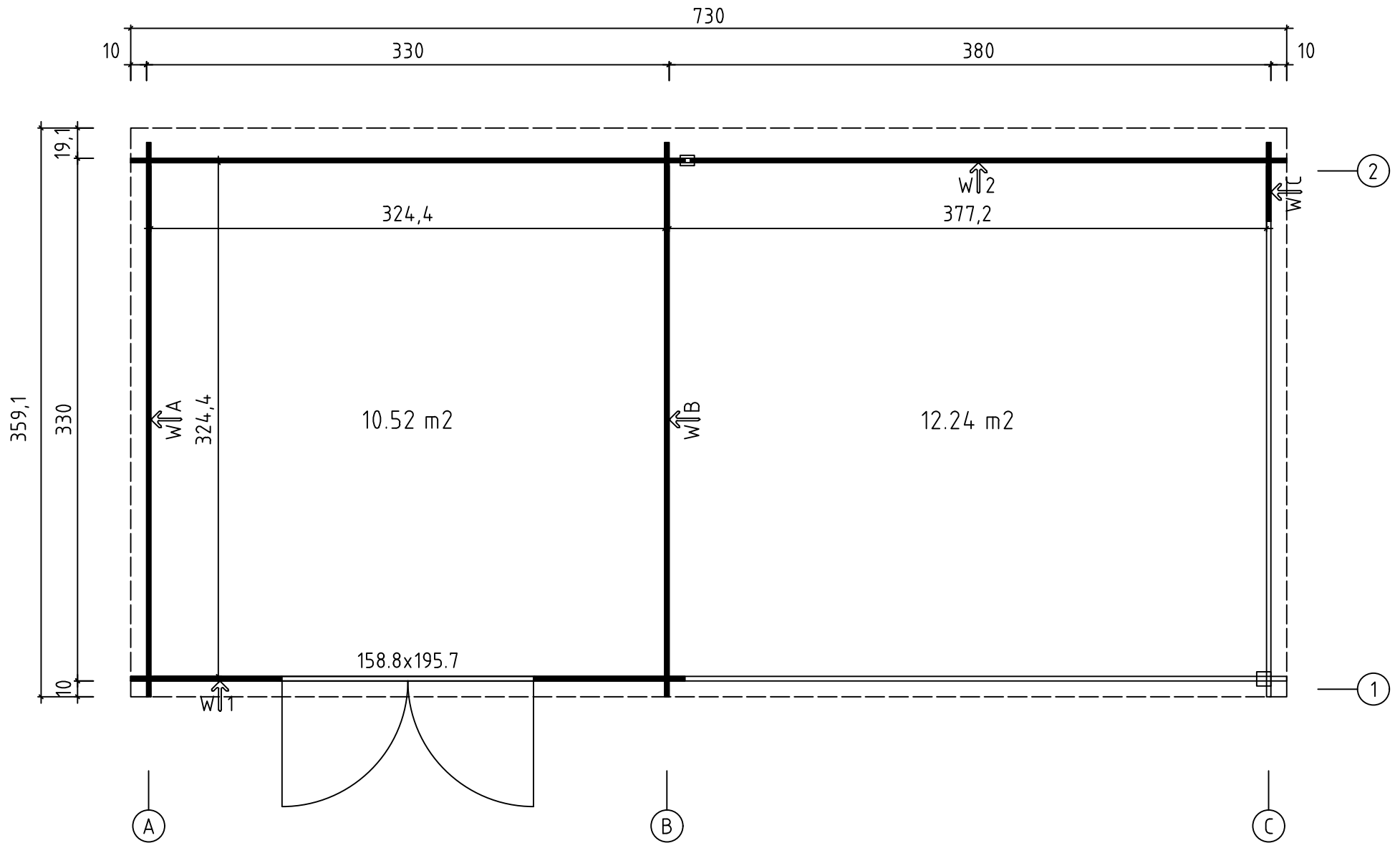

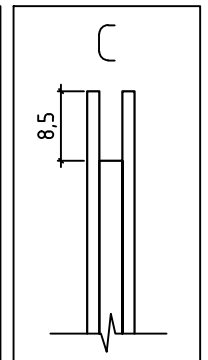
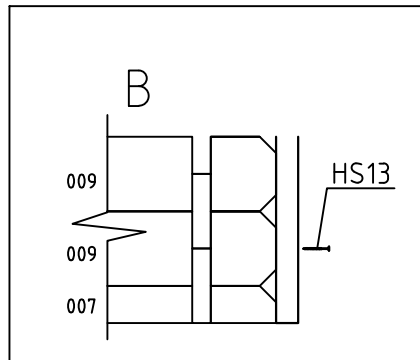
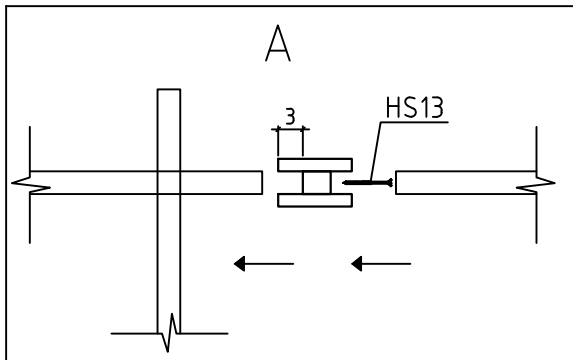
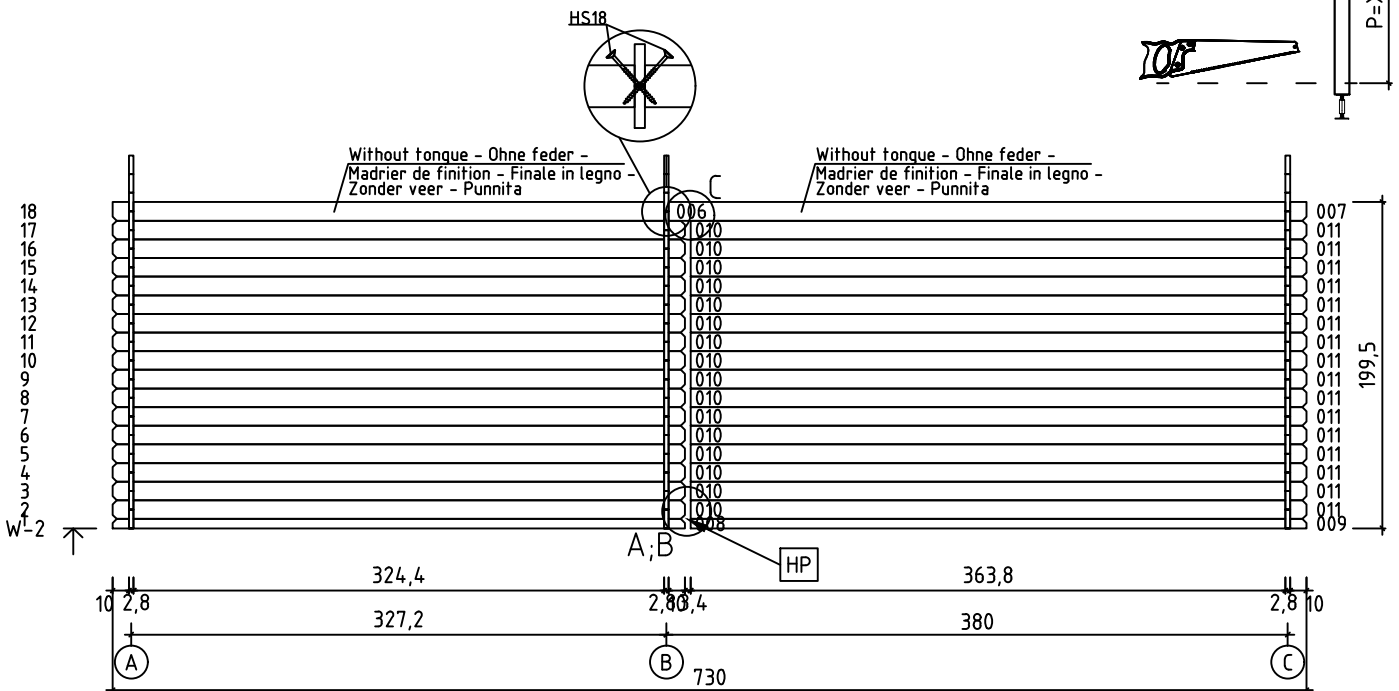
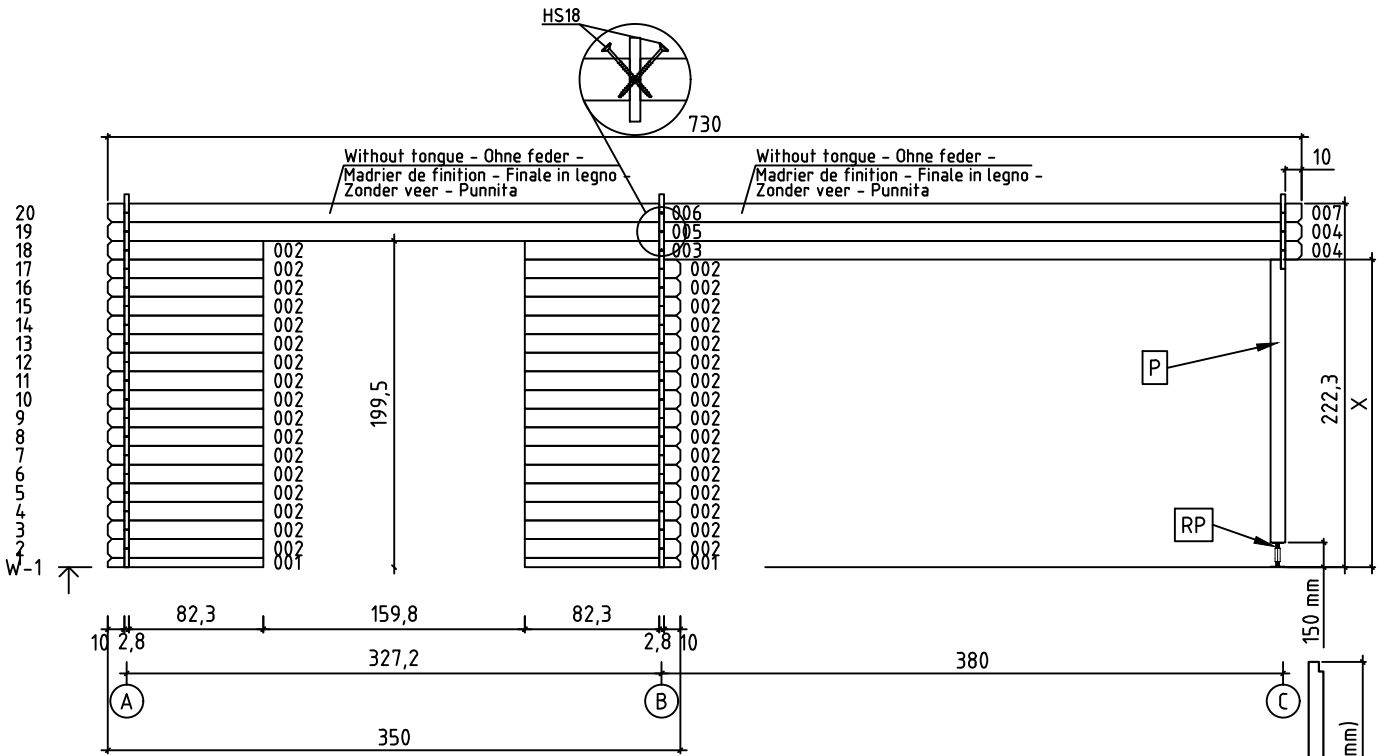
07.02.2024

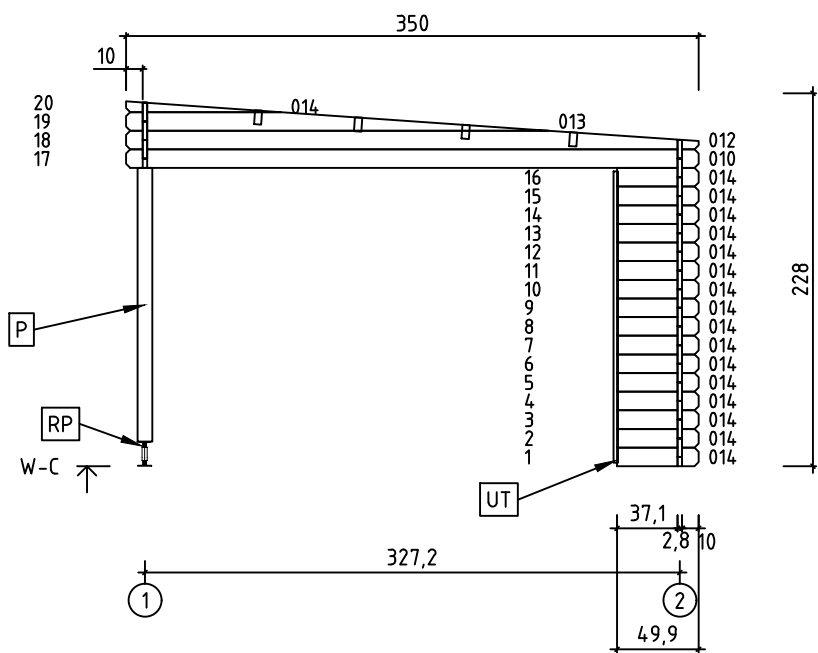
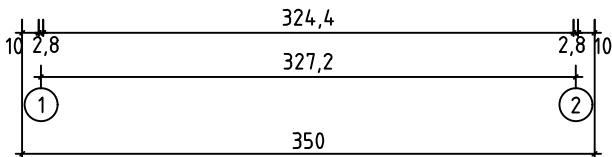
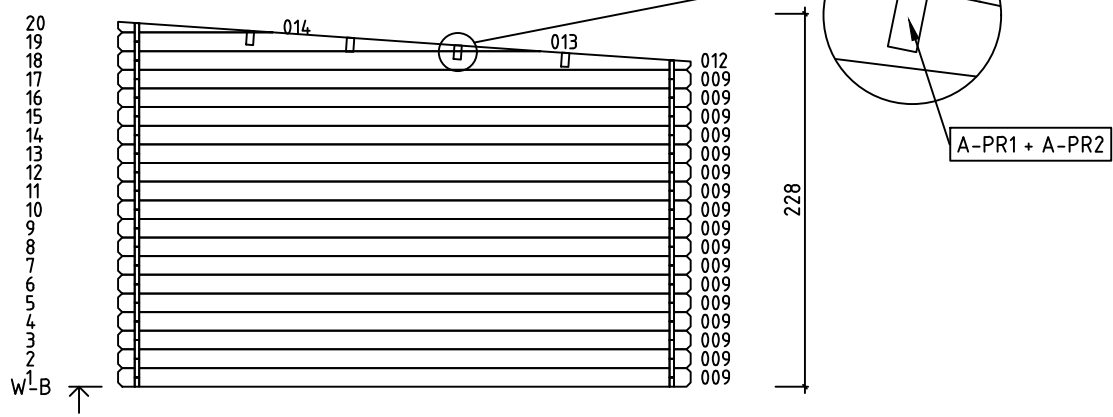
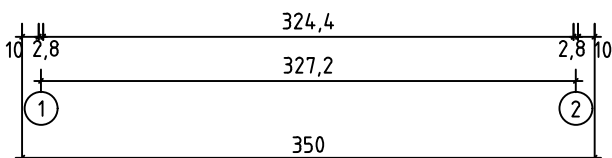
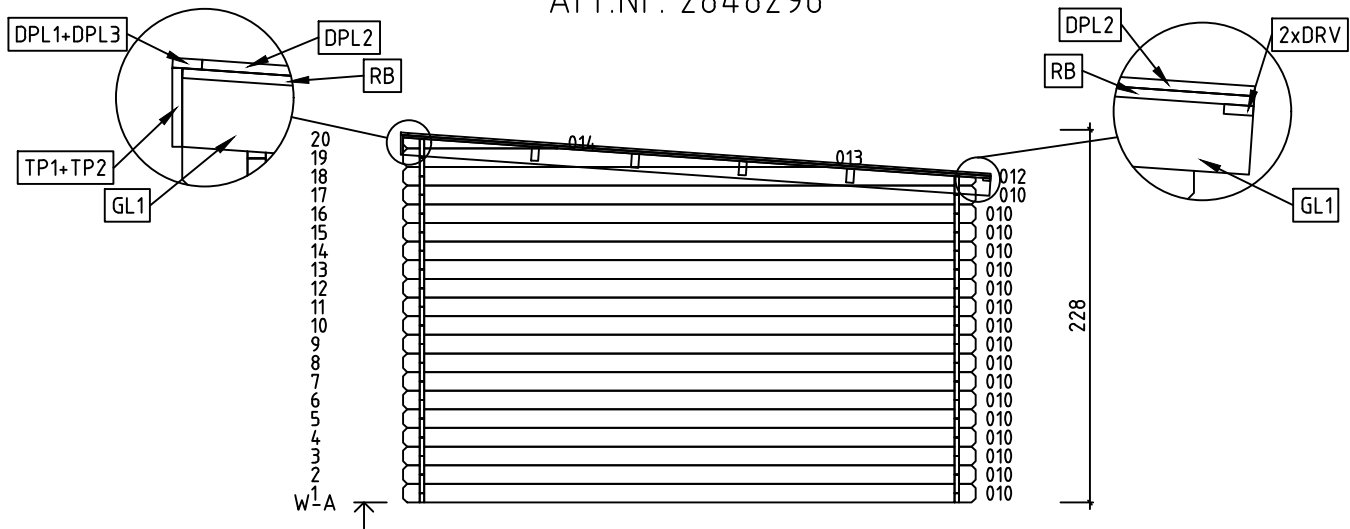

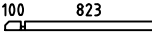
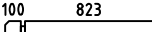
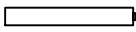
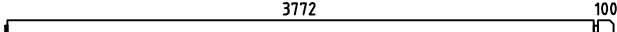
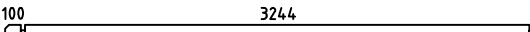
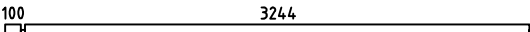
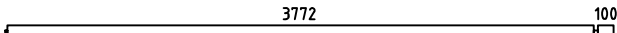
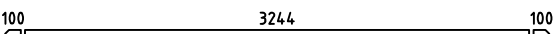
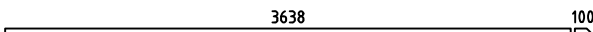
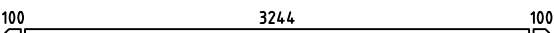
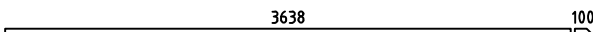

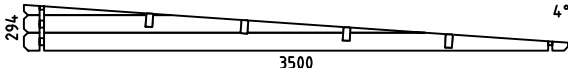
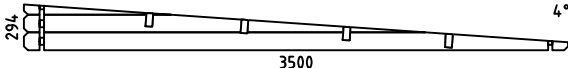
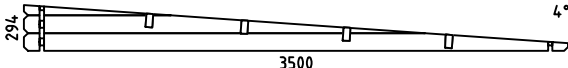
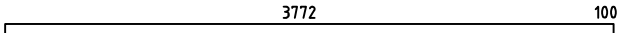
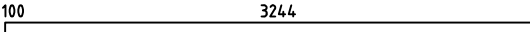
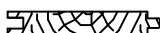





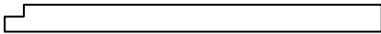

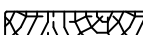
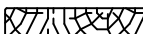



Art.Nr. 2848296  
 Groundplan - Grundplan - Plan de masse - Planimetria - Plattegrond  
 - Planimetría - Põhiplaan

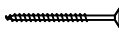

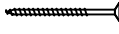
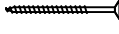
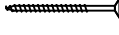
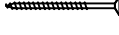







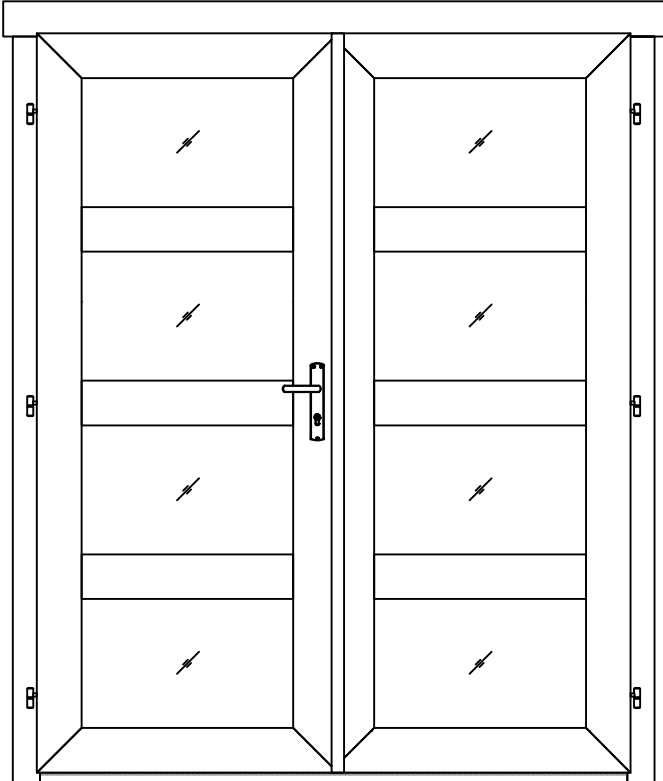
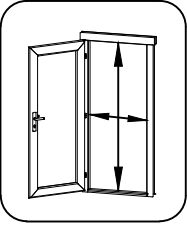
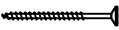
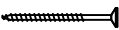

Pos	07.02.2024 Piece list - Stückliste - Liste des pièces - Elementi - Stuklijst - Elementos - Tükítabel Art.Nr. 2848296	5/7	Q	P (mm)	L (mm)
001 39740			2	28x57	951
002 1319			33	28x114	951
003 39741			1	28x114	837
004 34546			2	28x114	3914
005 37515			1	28x114	3386
006 37563			2	28x114	3386
007 37566			2	28x114	3914
008 32528			1	28x57	3500
009 34555			1	28x57	3766
010 32526			51	28x114	3500
011 34567			16	28x114	3766
015 932			16	28x114	499
WA-1 37569			1		
WB-1 37569			1		
WC-1 37569			1		
A-PR2 34559	Roof beam - Dachbalken - Panne de toit - Perlina del tetto - Gordingen / dakbalk - Correa - Pärlin 		4	44x146	3914
A-PR1 37518	Roof beam - Dachbalken - Panne de toit - Perlina del tetto - Gordingen / dakbalk - Correa - Pärlin 		4	44x146	3386
RB 37571	Roof boards - Dachbretter - Voliges - Perlina per tetto - Dakhout - Tablero de tejado - Katuselaud 		82	90x15.5	3600
DPL1 22407	Roofing felt fillet - Dachpappenleiste - Baguette de fixation du feutre bitumeux - Asse per fissaggio guaina bituminosa - Afdeklijst asfaltpapier - Moldura de fieltro para tejado - Katusepapiiist 		1	15x45	3400
DPL2 37572	Roofing felt fillet - Dachpappenleiste - Baguette de fixation du feutre bitumeux - Asse per fissaggio guaina bituminosa - Afdeklijst asfaltpapier - Moldura de fieltro para tejado - Katusepapiiist 		2	15x45	3570
DPL3 37573	Roofing felt fillet - Dachpappenleiste - Baguette de fixation du feutre bitumeux - Asse per fissaggio guaina bituminosa - Afdeklijst asfaltpapier - Moldura de fieltro para tejado - Katusepapiiist 		1	15x45	3930

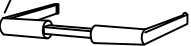
Pos	Piece list - Stückliste - Liste des pièces - Elementi - Stuklijst - Elementos - Tükítabel 07.02.2024 Art.Nr. 2848296 6/7	Q	P (mm)	L (mm)
P 36570	Post - Pfosten - Poteau - Piede registrabile - Stijl - Poste - Post 	1	90x90	1780
HP 35004	H-profile - H-profils - Profile H - Profilo ad H - H-profiel - Perfil en H - H-profiil 	1	58x90	1935
TB1 23046	Fascia board - Traufbrett - Bandeau de toit - Finitura lati tetto - Gevellijst - Tablero de alero  - Räästalaud	1	15x120	3400
TB2 37576	Fascia board - Traufbrett - Bandeau de toit - Finitura lati tetto - Gevellijst - Tablero de alero  - Räästalaud	1	15x120	3930
DRV 37519	Roof edge reinforcement - Dachrandverstärkung - Corniere de renfort de bord de toit - Rinforzo x tetto - Dakrand versterking - Refuerzo de aleros - Räästatugevdus 	2	15x45	3650
KFS-1 2249	Storm protection - Sturmleiste - Latte anti-tempete - Protezione anti vento - Stormverankering / beveliging - Moldura antitormenta - Tormikinnitusliist 	3	22x45	2050
KFS-2 27180	Storm protection - Sturmleiste - Latte anti-tempete - Protezione anti vento - Stormverankering / beveliging - Moldura antitormenta - Tormikinnitusliist 	2	22x45	2500
UT 34526	U-profile - U-profils - Profile u - Profilo ad u - U-profiel - Perfil en U - U-profiil 	1	28x58	1780
GL1 37574	Gable moulding - Giebelleiste - Planche de rive - Finitura per frontale e retro del tetto - Gevellijst - Tablero de frontón - Viilulaud 	2	15x120	3600
HS9 5106	Screw for u-profile - Schraube zur befestigung u-profils - Vis a tete fraisée pour profil u - Vite per profilo ad u - Schroef ter bevestiging u-profiel - Tornillo para perfil en U - Kruvi U-profiilile 	6	3.5x50	
HS9 5106	Screw for gable moulding - Schrauben für giebelleiste - Vis pour fixation planche de rive - Vite per fissare finiture davanti e dietro del tetto - Schroef voor gevellijst - Tornillo para tablero de frontón - Kruvi viilulauale 	32	3.5x50	
HS4 5102	Screw for roof edge reinforcement - Schrauben für dachrandverstärkung - Vis pour fixation corniere renfort de bord de toit - Viti x rinforzo bordo tetto - Schroef voor dakrand versterking - Tornillo para refuerzo de alero - Kruvi räästatugevdusele 	16	3x30	
HS14 5111	Screw for post - Schrauben für pfosten - Vis de fixation des poteaux - Viti per inviare - Schroef voor stijlen - Tornillo para poste - Kruvi postile 	2	4.5x80	
HS13 5110	Screw for h-profile - Schraube zur befestigung h-profils - Vis a tete fraisée pour profil h - Vite per profilo ad h - Schroef ter bevestiging h-profiel - Tornillo para perfil en H - Kruvi H-profiilile 	1	4x60	
HS18 5113	Screw for roof beams - Schrauben für dachbalken - Vis pour fixation pannes de toit - Viti per perline del tetto - Schroef voor gordingen / dakbalken - Tornillo para correas - Kruvi pärlinitile 	16	5x120	
HS18 5113	Screw for wall details - Schraube für wand details - Vis pour mur details - Viti per elementi della porta - Schroef voor wand details - Tornillo para elementos de pared - Kruvi seinadetailidele 	8	5x120	
HS18 5113	Screw for gable - Schrauben für giebel - Vis pour fixation des pignons - Viti per timpano - Schroef voor gevelpunt - Tornillo para fijación de frontones - Kruvi viilude kinnitamiseks 	6	5x120	
HS20 5118	Screw for post height adjustment - Schrauben für regulierungsschraube für pfosten - Vis de fixation de support réglable de poteau - Viti per fissare ed aggiustare l'altezza del palo verticale - Schroef voor hoogte instelling stijlen - Tornillo para anclaje - Kruvi vajumispoldile 	8	6x50	
SH28 32509	Hammer block - Schlagholz - Calle de frappe - Blocco di legno da usare come cuscinetto quando si usa il martello - Slagklos - Bloque de impacto - Löögiklots 	1		
SFS 5133	Nut for storm protection - Schraubenmutter für sturmleiste - Ecrou pour latte anti-tempete - Dado x asta protezone vento - Moer voor stromverankering - Tuerca para moldura antitormenta - Mutter tormikinnitusliistule 	10	D6	
NF4 5137	Zn nail for roof - Zn nägel für dachbretter - Pointe pour fixation voliges de toit - Chiodi x perline tetto - Spijker(nagel) voor dakhout - Clavo para tablero de tejado - Nael katuselauale 	513	2x50	

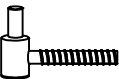

Pos	12.04.2017	Piece list - Stückliste - Liste des pièces - Elementi - Stuklijst - Tükítabel 1588x1957 TUK.4.020.SVV.MM SGC	1/1	Q	P (mm)	L (mm)
		Glass size - Glasgröße - Taille de la vitre - Misura del vetro - Glas afmeting - Klaasi mõõt: 561x348 mm				
		  <p>1488x1875 mm</p>				
HS4	Screw for door fillet - Schraube zur Befestigung Türleiste - Vis pour fixation baguette d'arrêt de porte - Viti per massellino della porta - Schroef voor deurlijst - Krugi ukse kokkuvaltšiliistule		5	3x30		
HS16	Screw for door jamb - Schraube für Türrahmen - Vis de fixation partie haute avec montants du cadre de porte - Viti x fissaggio montanti porte - Schroef voor deurkozijn - Krugi ukse lengile		4	5x90		
HS25	Screw for doorstep - Schrauben für swelle - Vis pour fixation barre de seuil - Vite per soglia della porta - Schroef voor deurdorpel - Krugi lävepakule		5	4.5x65		
TL4	Door handle fittings - Türgriff - Poignée de porte - Maniglie - Deurhendel / klink - Ukse käepide		1			
TL5	Set of door lock covers - Schlossblenden - Set de garnitures de porte - Copertura serrature - Slot sluitplaat set - Ukse lukuplaat		1			
	Cylinder lock - Zylinderschloss - Barillet de porte - Serratura - Cylinder slot - Ukse lukusüdamik		1	30x35		
	Male bolt hinge for door - Türband - Partie male de paumelle de porte - Cerniera anube x porta - Scharnier bout - Ukse polthing isane		6			
	Striker for barrel bolt - Hülse für Grendelriegel - Gache au sol du targette - Boccola per fermo della porta - Huls voor vergrendelingsschuif - Vasturaud ukse servariivile		2			