

*Kirian 300*  
Art. Nr. 2839296  
1/6

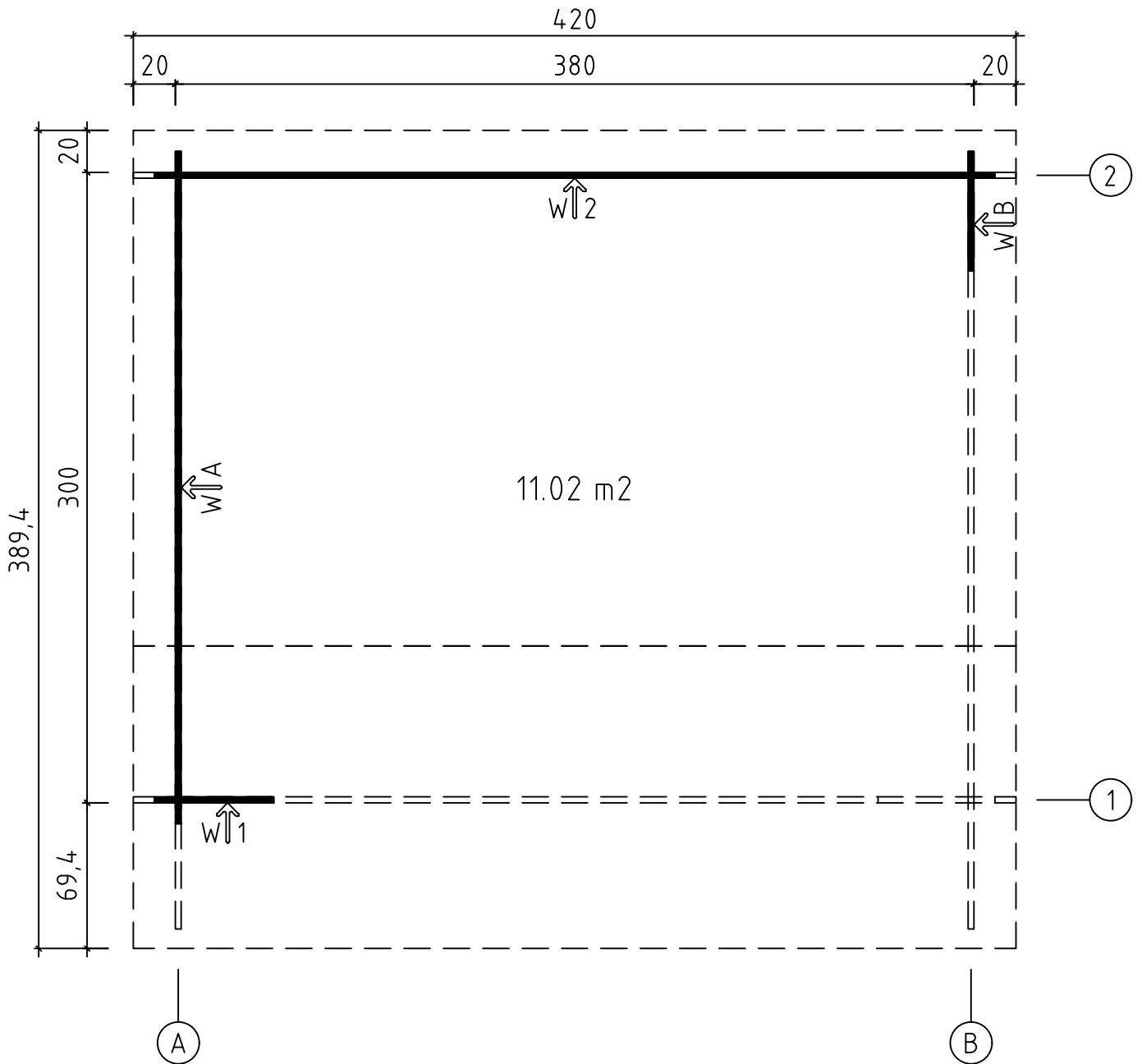

07.11.2017

Groundplan - Grundplan - Plan de masse - Planimetria -  
Plattegrond - Põhiplaan





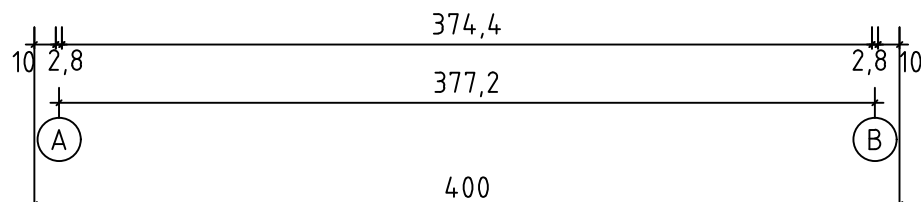
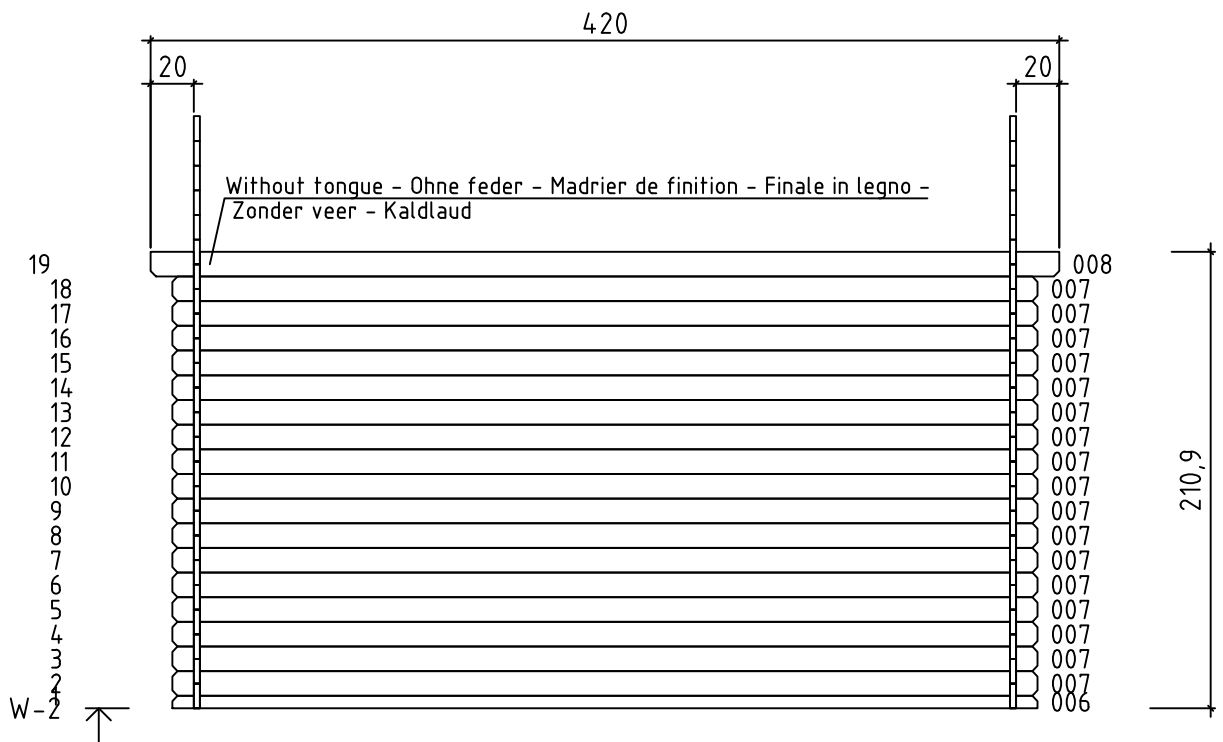
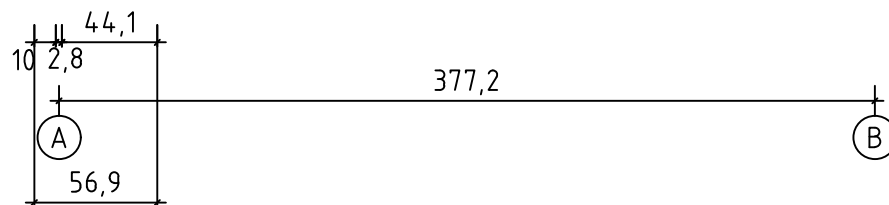
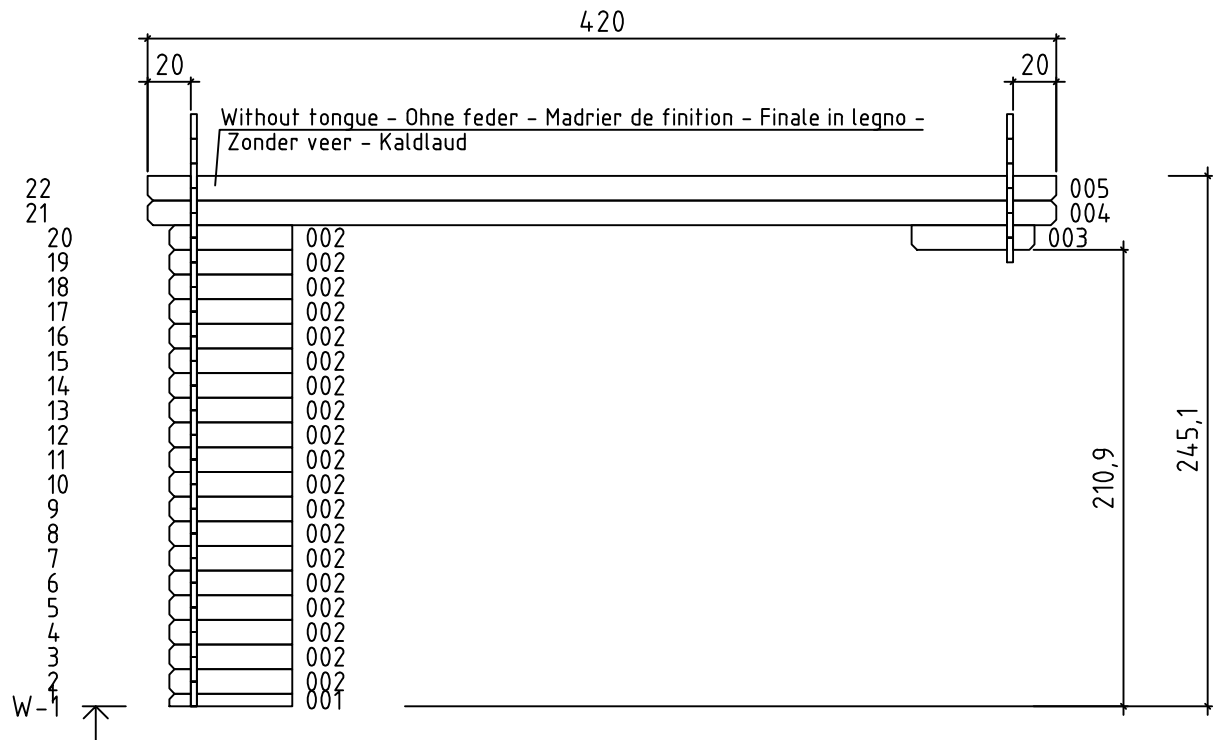



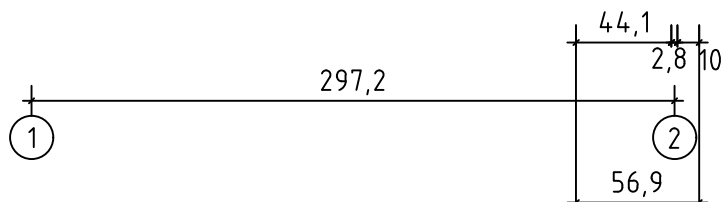
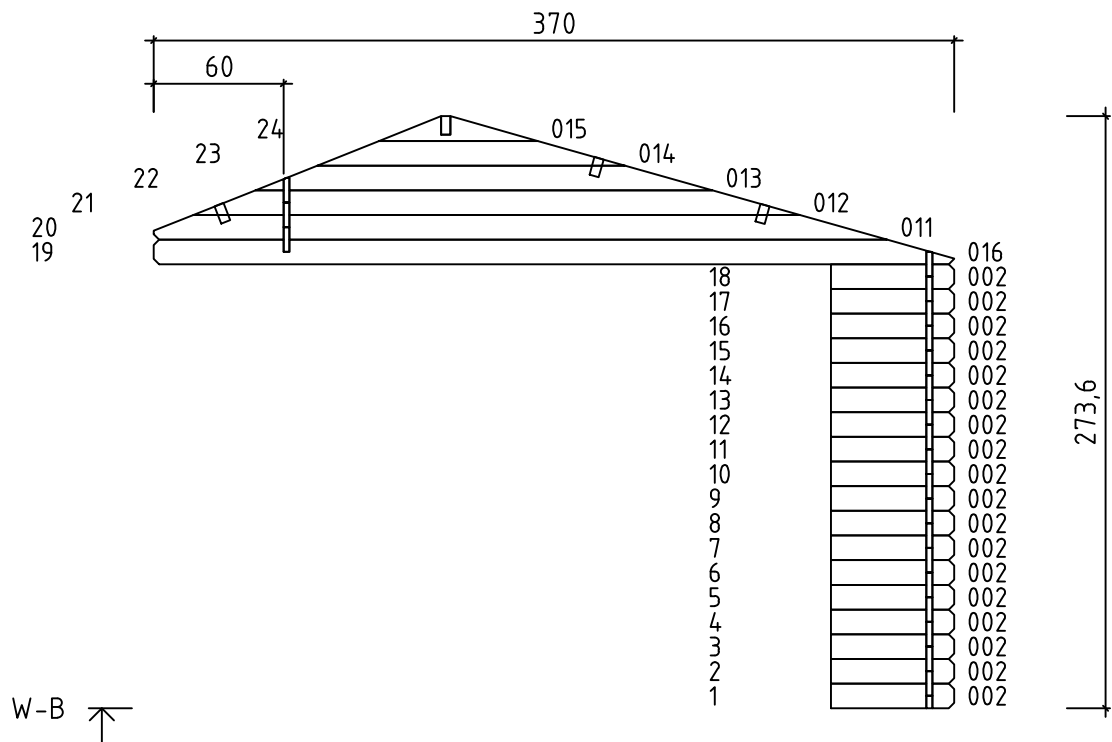
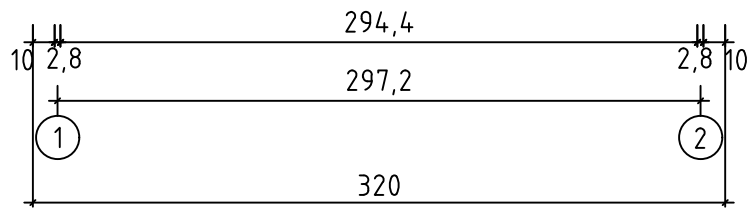
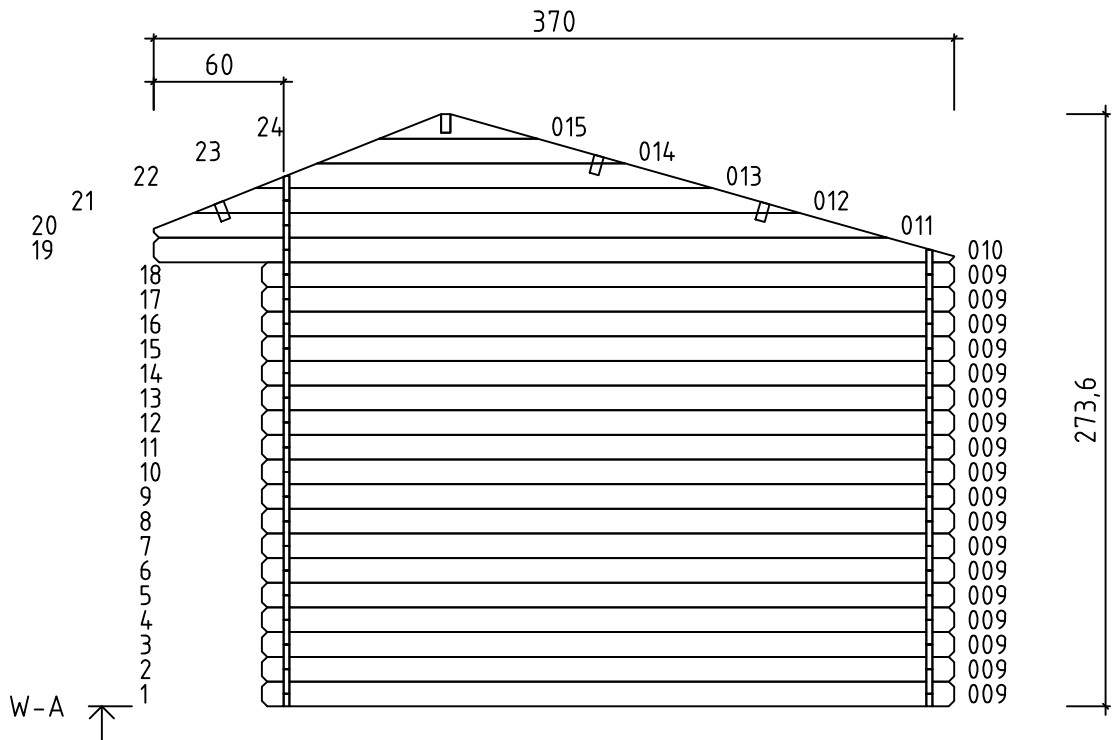



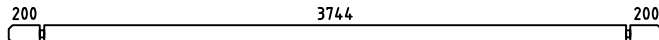
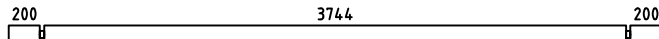
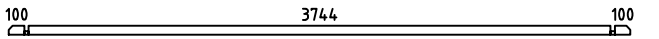
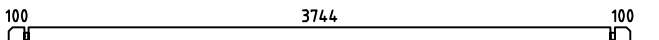
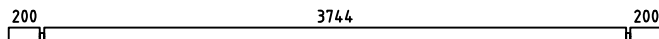
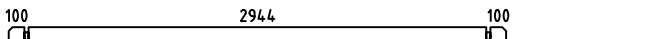
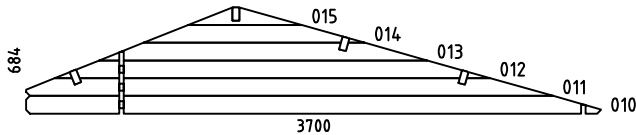
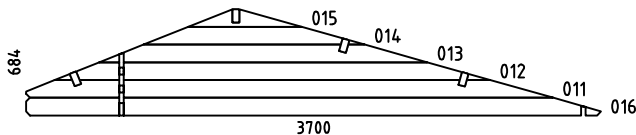
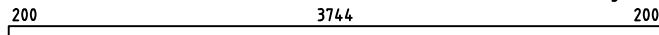
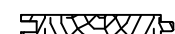

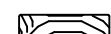
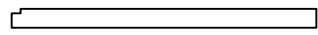

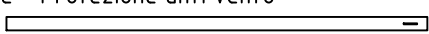
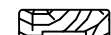
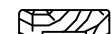

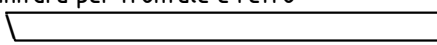
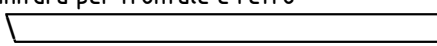



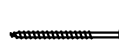

Art. Nr. 2839296

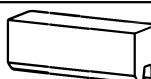

Art. Nr. 2839296

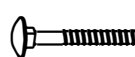

Pos	07.11.2017 Piece list - Stückliste - Liste des pièces - Elementi - Stuklijst - Tükítabel Art. Nr. 2839296 5/6	Q	P (mm)	L (mm)
001		1	28x57	569
002		37	28x114	569
003		1	28x114	569
004		1	28x114	4200
005		1	28x120	4200
006		1	28x57	4000
007		17	28x114	4000
008		1	28x120	4200
009		18	28x114	3200
WA-1		1		
WB-1		1		
A-PR1	Roof beam - Dachbalken - Panne de toit - Perlina del tetto - Gordingen / dakbalk - Pärilin 	4	44x140	4200
	Roof boards - Dachbretter - Voliges - Perlina per tetto - Dakhout - Katuselaud 	47	90x15	2550
	Roof boards - Dachbretter - Voliges - Perlina per tetto - Dakhout - Katuselaud 	47	90x15	1550
	Roofing felt fillet - Dachpappenleiste - Baguette de fixation du feutre bitumeux - Asse per fissaggio guaina bituminosa - Afdekljst asfaltpapier - Katusepapiilist 	2	15x45	1600
	Roofing felt fillet - Dachpappenleiste - Baguette de fixation du feutre bitumeux - Asse per fissaggio guaina bituminosa - Afdekljst asfaltpapier - Katusepapiilist 	2	15x45	2600
	Post - Pfosten - Poteau - Piede registrabile - Stijl - Post 	1	120x120	1960
DRV-1	Roof edge reinforcement - Dachrandverstärkung - Corniere de renfort de bord de toit - Rinforzo x tetto - Dakrand versterking - Räästatugevdus 	2	15x45	4200
KFS-1	Storm protection - Sturmleiste - Latte anti-tempete - Protezione anti vento - Stormverankering / beveiliging - Tormikinnitusliist 	4	22x45	2500
	U-profile - U-profiils - Profile u - Profilo ad u - U-profiel - U-profiil 	1	28x58	2017
	U-profile - U-profiils - Profile u - Profilo ad u - U-profiel - U-profiil 	1	28x58	2190

Pos	07.11.2017 Piece list - Stückliste - Liste des pièces - Elementi - Stuklijst - Tükítabel Art. Nr. 2839296 6/6	Q	P (mm)	L (mm)
	Gable moulding - Giebelleiste - Planche de rive - Finitura per frontale e retro del tetto - Gevellijst - Viilulaud 	2	15x120	1600
	Gable moulding - Giebelleiste - Planche de rive - Finitura per frontale e retro del tetto - Gevellijst - Viilulaud 	2	15x120	2600
HS8	Screw for gable segment - Schrauben für deckblatt - Vis pour fixation losange de finition - Viti x frontali tetto - Schroef voor gevelpunt segment - Kruvi rombile 	4	3.5x35	
HS9	Screw for u-profile - Schraube zur befestigung u-profils - Vis a tete fraisée pour profil u - Vite per profilo ad u - Schroef ter bevestiging u-profiel - Kruvi U-profiilite 	10	3.5x50	
HS9	Screw for gable moulding - Schrauben für giebelleiste - Vis pour fixation planche de rive - Vite per fissare finiture davanti e dietro del tetto - Schroef voor gevellijst - Kruvi viilulauale 	28	3.5x50	
HS4	Screw for roof edge reinforcement - Schrauben für dachrandverstärkung - Vis pour fixation corniere renfort de bord de toit - Viti x rinforzo bordo tetto - Schroef voor dakrand versterking - Kruvi räästatugevdusele 	18	3x30	
HS18	Screw for roof beams - Schrauben für dachbalken - Vis pour fixation pannes de toit - Viti per perline del tetto - Schroef voor gordingen / dakbalken - Kruvi pärlinitele 	8	5x120	
HS18	Screw for gable - Schrauben für giebel - Vis pour fixation des pignons - Viti per timpano - Schroef voor gevelpunt - Kruvi viilude kinnitamiseks 	4	5x120	
HS16	Screw for post - Schrauben für pfosten - Vis de fixation des poteaux - Viti per inviare - Schroef voor stijlen - Kruvi postile 	2	5x90	
HS20	Screw for post height adjustment - Schrauben für regulierungsschraube für pfosten - Vis de fixation de support réglable de poteau - Viti per fissare ed aggiustare l'altezza del palo verticale - Schroef voor hoogte instelling stijlen - Kruvi vajumispolidile 	8	6x50	
SH28	Hammer block - Schlagholz - Calle de frappe - Blocco di legno da usare come cuscinetto quando si usa il martello - Slagklos - Löögiklots 	1		
SFS	Nut for storm protection - Schraubenmutter für sturmleiste - Erou pour latte anti-tempete - Dado x asta protezione vento - Moer voor stromverankering - Mutter tormikinnitusliistule 	8	D6	
NF4	Zn nail for roof - Zn nägel für dachbretter - Pointe pour fixation voliges de toit - Chiodi x perline tetto - Spijker(nagel) voor dakhout - Nael katuselauale 	346	2x50	
NF5	Zn nail for roofing felt fillet - Zn nägel für dachpappenleiste - Pointe pour baguette de fixation feutre bitumeux - Chiodi x carta bituminosa x tetto - Spijker(nagel) voor asfaltpapier afdekljst - Papiliistunael 	20	2x40	
BFS	Bolt for storm protection - Bolzen für sturmleiste - Boulon pour latte anti-tempete - Bullone x asta protezione vento - Bout voor stormankerlat - Puidupolt tormikinnitusliistule 	8	6x60	
GS	Gable segment - Deckblatt - Losange de finition - Decorazione in legno x frontale tetto - Gevelpunt segment - Romb 	2		
DFS	Washer for storm protection - Dichtscheibe für sturmleiste - Rondelle pour latte anti-tempete - Rondella x asta protezione vento - Afdichtring voor storm strip - Seib tormikinnitusliistule 	8	D6	
	Post height adjustment - Regulierungsschraube für pfosten - Support réglable de poteau - Piede registrabile in altezza - Stelschroef voor stijlpost - Vajumispolt 	1	D20	