

*Bingham 6*  
*Art. Nr. 4426902*  
1/9

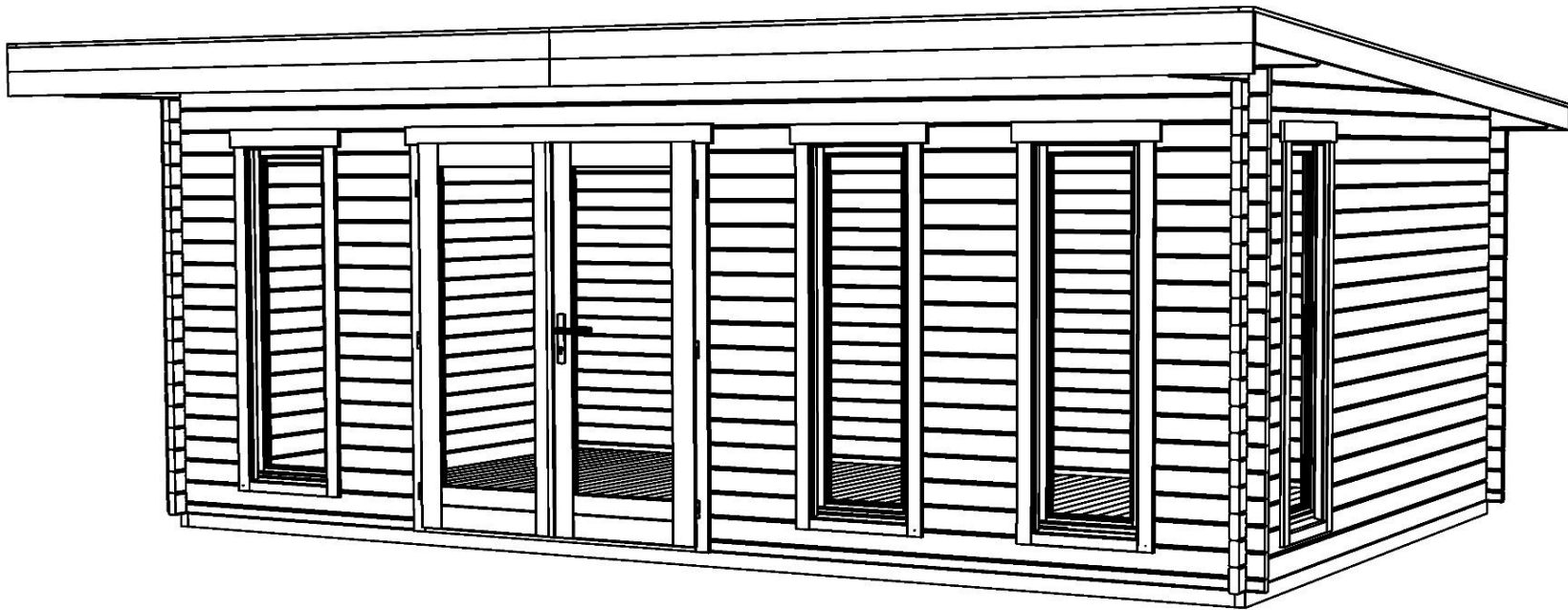

Art. Nr. 4426902

Groundplan - Grundplan - Plan de masse - Planimetria - Plattegrond - Põhiplaan

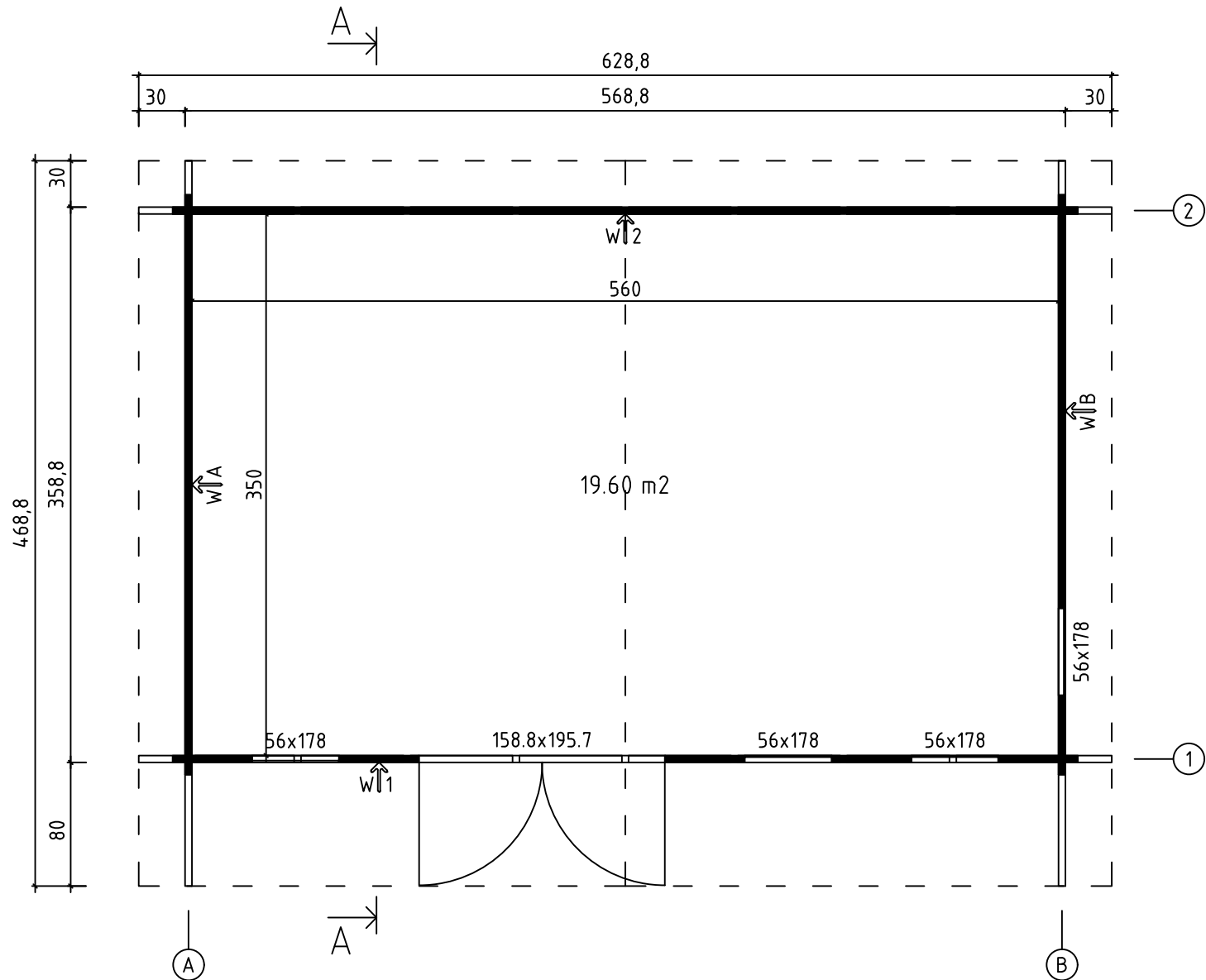

25.05.2021

2/9

Art. Nr. 4426902

Foundation - Fundament - Fondation -  
Fundamenta - Fundering - Immutatud alusraam

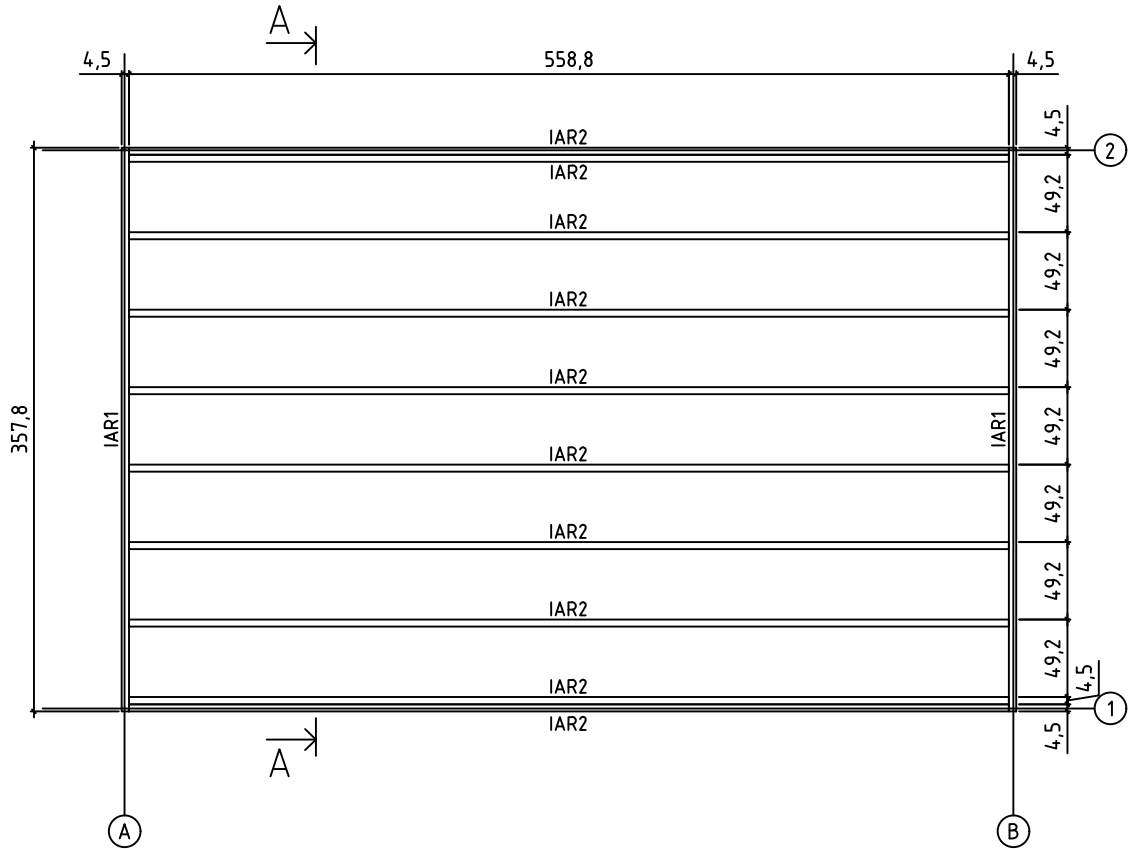

Floor boards - Fussbodenbretter - Plan pose plancher -  
Pavimento - Vloerhout - Põrandalaudis

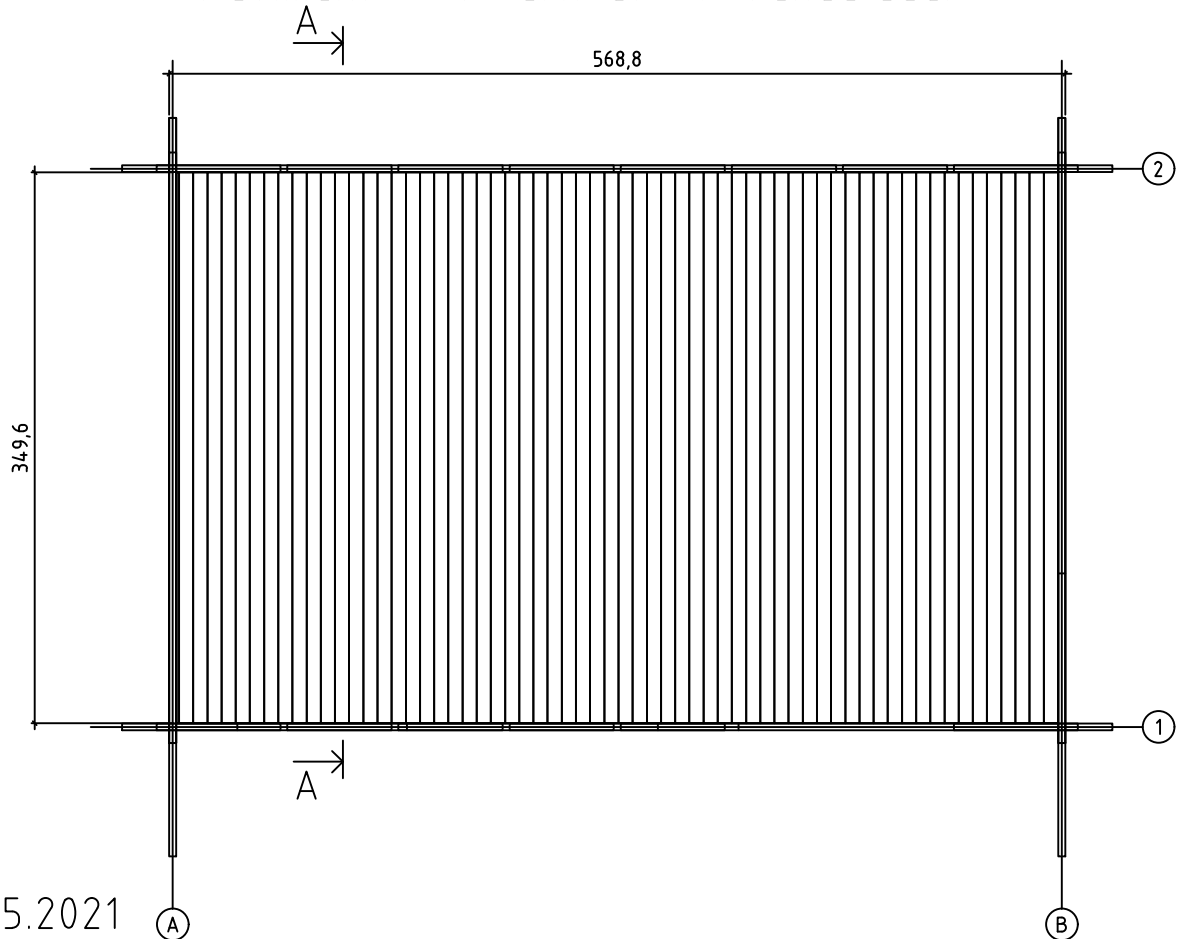

25.05.2021

3/9

Rafters plan - Dachsparren - Plan de chevron - Piano di travi -  
Dak spar constructie plattegrond - Sarikaplaan

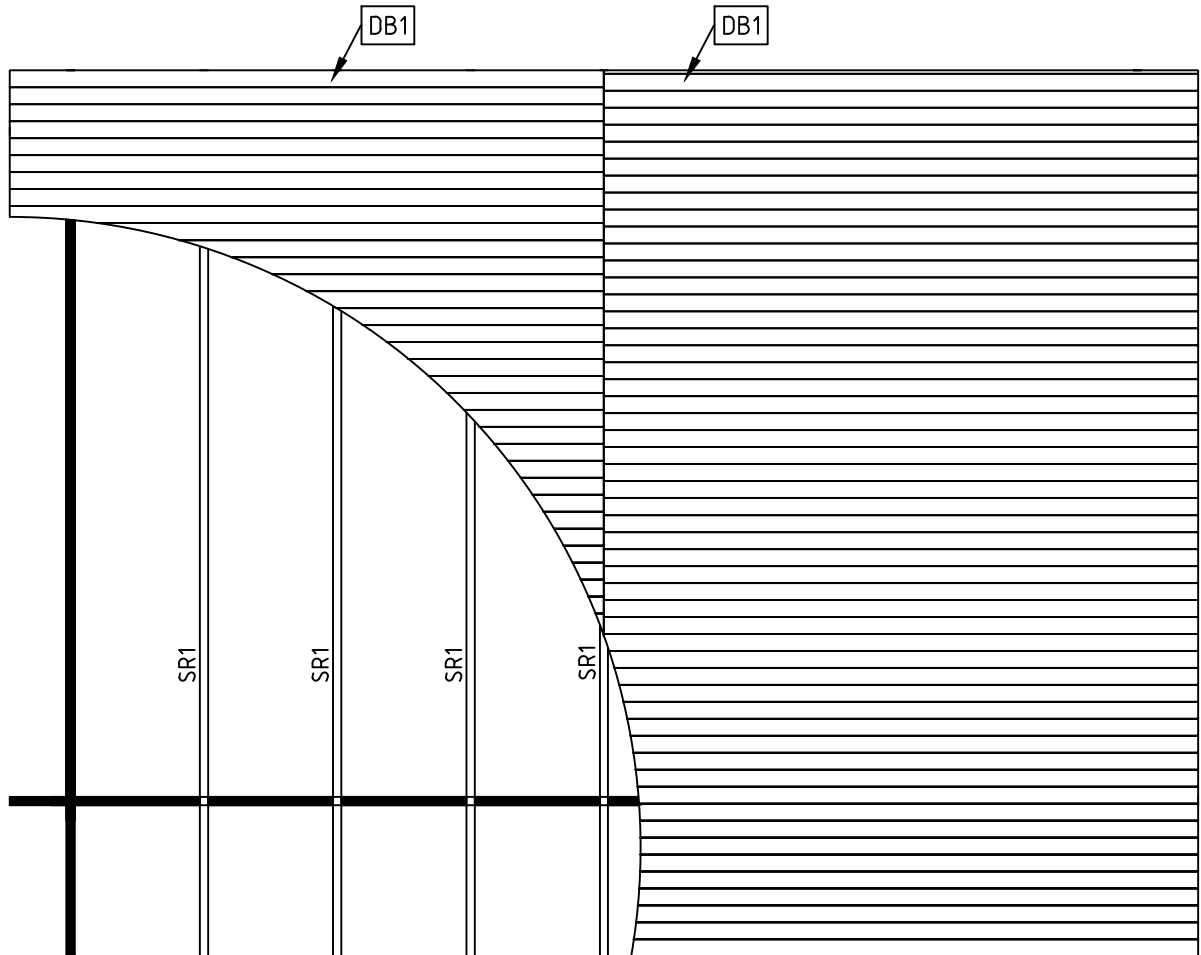

Art.Nr. 4426902

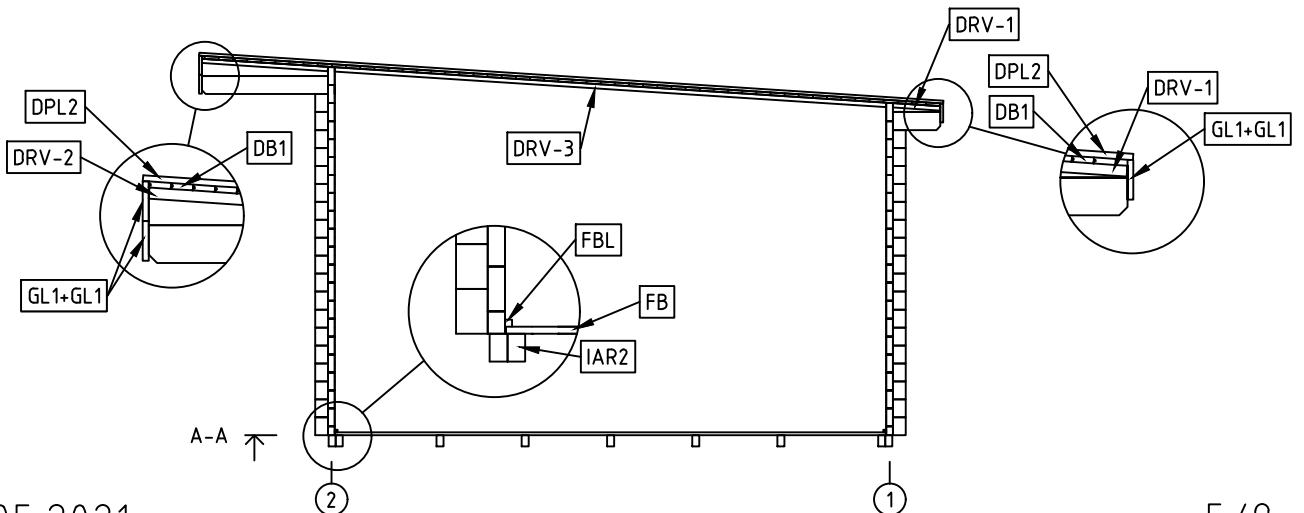
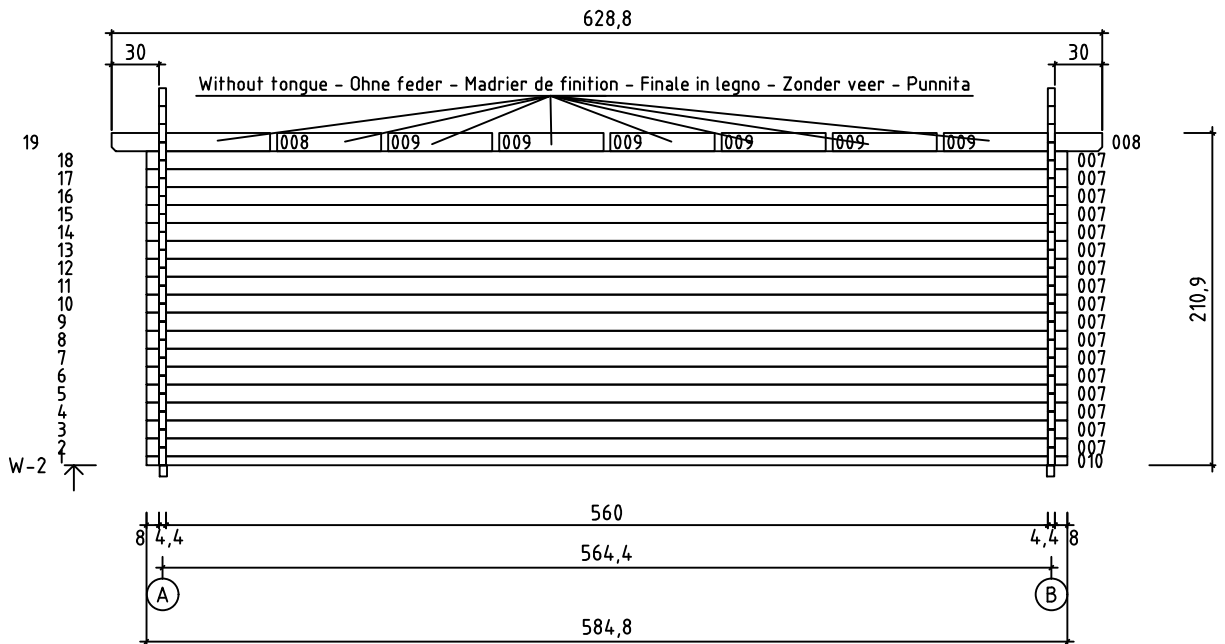
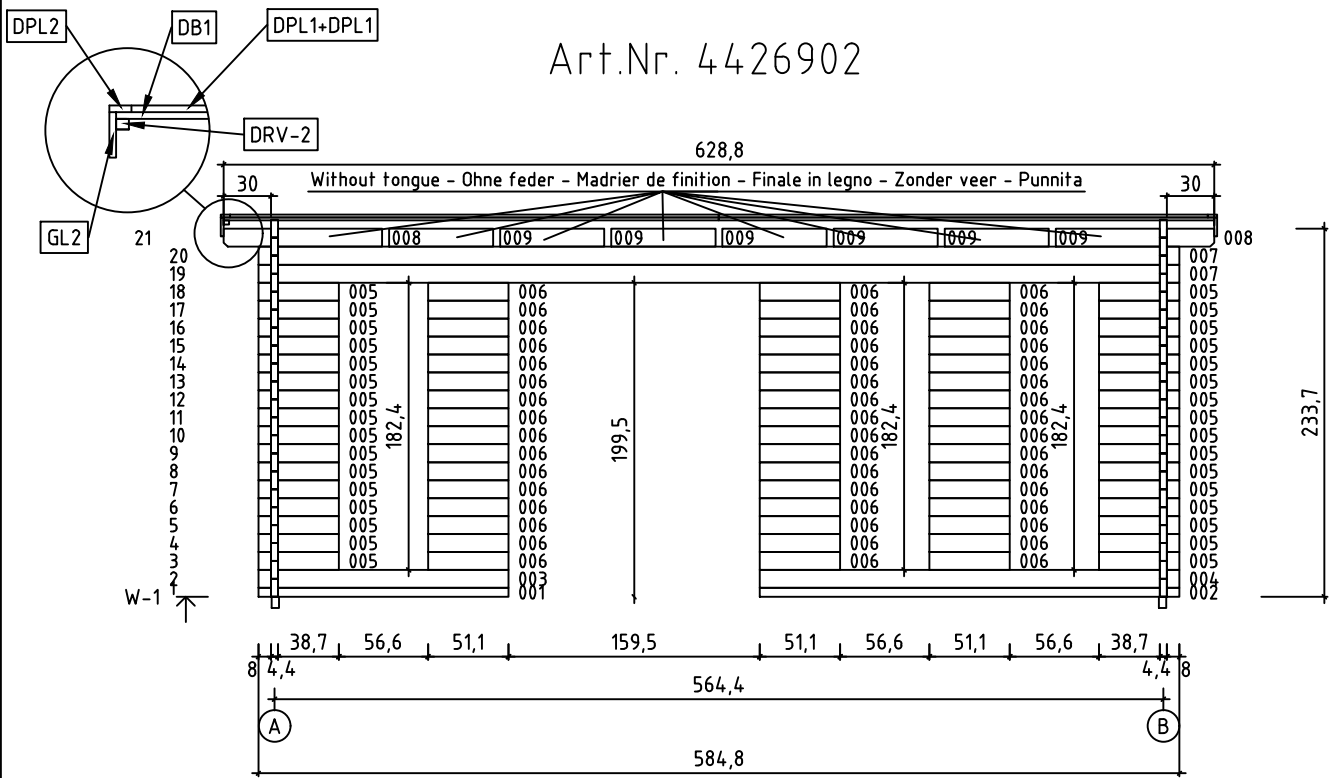







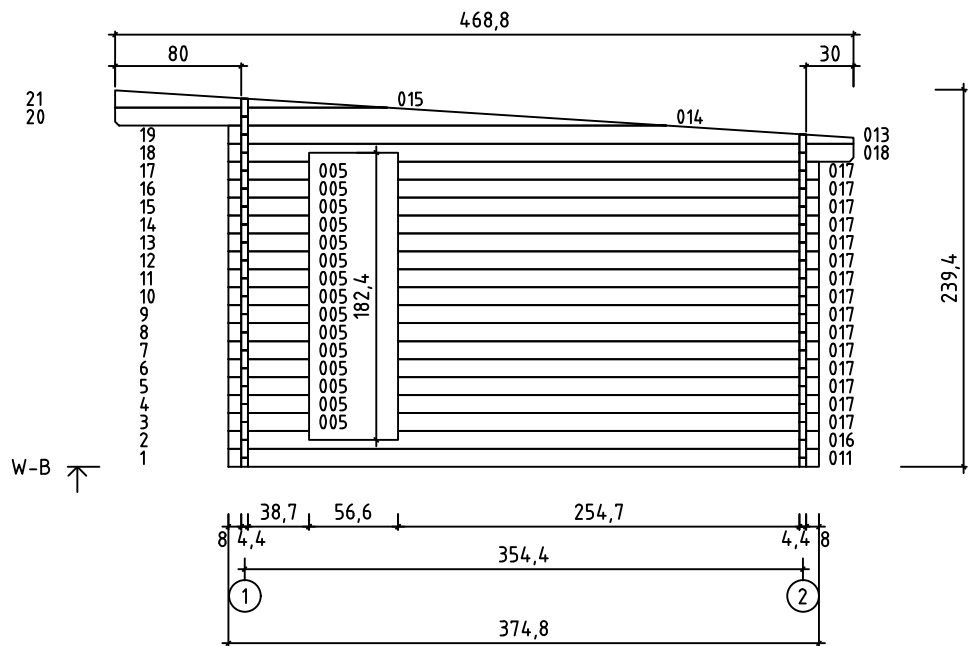
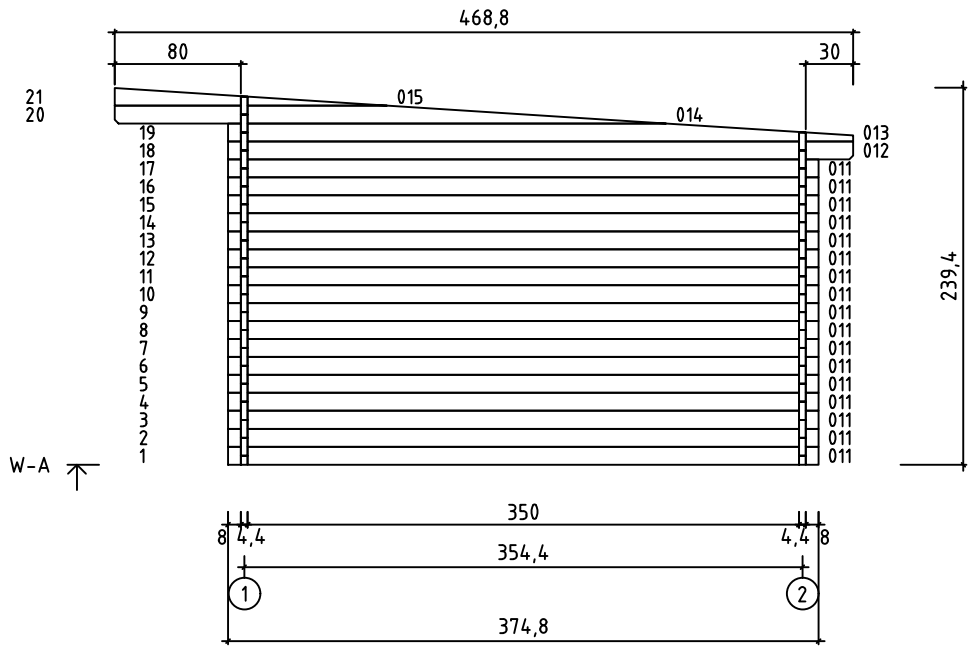

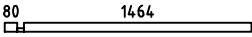
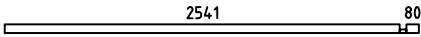
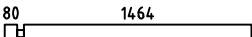
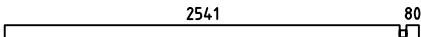

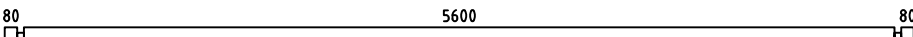
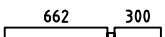
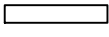
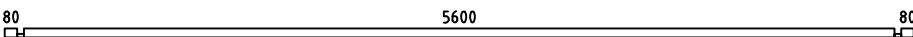
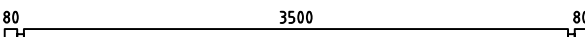
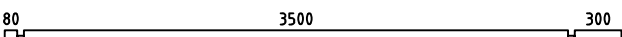
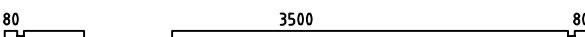
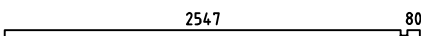
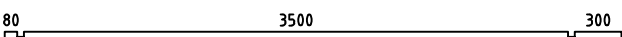
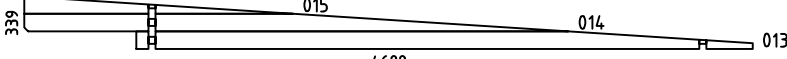
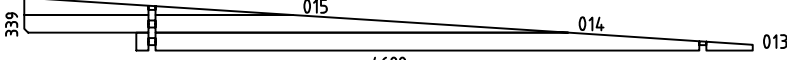









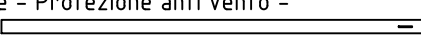
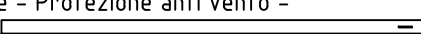

25.05.2021

5/9

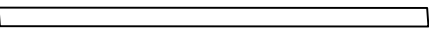
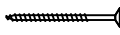
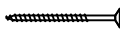
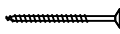
Art.Nr. 4426902

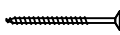
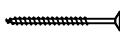
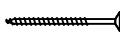
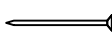



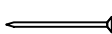
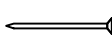

Pos	25.05.2021 Piece list - Stückliste - Liste des pièces - Elementi - Stuklijst - Tükítabel Art. Nr. 4426902 7/9	Q	P (mm)	L (mm)
001		1	44x57	1588
002		1	44x57	2665
003		1	44x114	1588
004		1	44x114	2665
005		47	44x114	511
006		48	44x114	511
007		19	44x114	5848
008		4	44x114	1006
009		12	44x114	662
010		1	44x57	5848
011		18	44x114	3748
012		1	44x114	3968
016		1	44x114	3748
017		15	44x114	2671
018		1	44x114	3968
WA-1		1		
WB-1		1		
IAR2	Foundation - Fundament - Fondation - Fondamenta - Fundering - Immutatud alusraam 	10	45x70	5588
IAR1	Foundation - Fundament - Fondation - Fondamenta - Fundering - Immutatud alusraam 	2	45x70	3578
SR1	SARIKAD 	7	44x140	4698
FB	Floor boards - Fussbodenbretter - Lame de plancher - Pavimento - Vloerhout - Põrandalaud 	63	90x18	3496
DB1	Roof boards - Dachbretter - Voliges - Perlina per tetto - Dakhout - Katuselaud 	106	90x18	3144
FBL	Floor fillet - Fussbodenleiste - Corniere de finition du plancher - Finitura per pavimento (battisco pa) - Vloerafwerklijst - Põrandaliist 		18x18	18.18



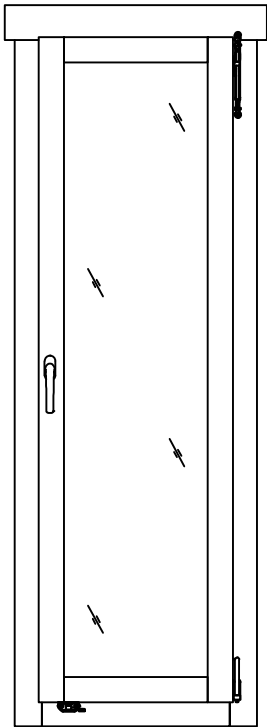
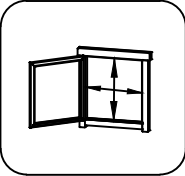

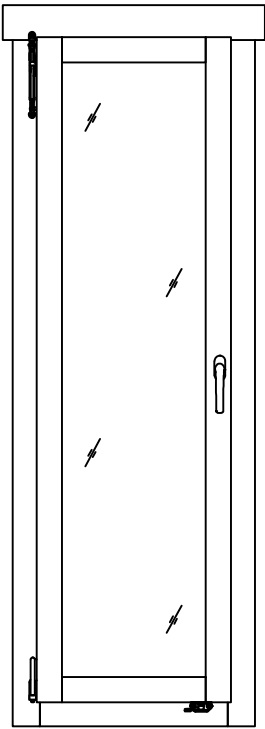
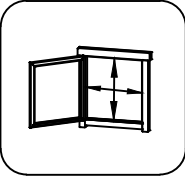

Pos	25.05.2021 Piece list - Stückliste - Liste des pièces - Elementi - Stuklijst - Tükitalabel Art. Nr. 4426902 8/9	Q	P (mm)	L (mm)
DPL1	Roofing felt fillet - Dachpappenleiste - Baguette de fixation du feutre bitumeux - Asse per fissaggio guaina bituminosa - Afdekljst asfaltpapier - Katusepapiilist 	2	18x58	3086
DPL2	Roofing felt fillet - Dachpappenleiste - Baguette de fixation du feutre bitumeux - Asse per fissaggio guaina bituminosa - Afdekljst asfaltpapier - Katusepapiilist 	2	18x58	4734
DRV-1	Roof edge reinforcement - Dachrandverstärkung - Corniere de renfort de bord de toit - Rinforzo x tetto - Dakrand versterking - Räästatugevdus 	2	28x34	299
DRV-2	Roof edge reinforcement - Dachrandverstärkung - Corniere de renfort de bord de toit - Rinforzo x tetto - Dakrand versterking - Räästatugevdus 	2	28x34	800
DRV-3	Roof edge reinforcement - Dachrandverstärkung - Corniere de renfort de bord de toit - Rinforzo x tetto - Dakrand versterking - Räästatugevdus 	2	28x34	3505
KFS-1	Storm protection - Sturmleiste - Latte anti-tempete - Protezione anti vento - Stormverankering / beveiliging - Tormikinnitusliist 	2	22x45	2050
KFS-2	Storm protection - Sturmleiste - Latte anti-tempete - Protezione anti vento - Stormverankering / beveiliging - Tormikinnitusliist 	2	22x45	2500
GL1	Gable moulding - Giebelleiste - Planche de rive - Finitura per frontale e retro del tetto - Gevellijst - Viilulaud 	6	18x120	3162
GL2	Gable moulding - Giebelleiste - Planche de rive - Finitura per frontale e retro del tetto - Gevellijst - Viilulaud 	2	18x120	4705
HS9	Screw for gable moulding - Schrauben für giebelleiste - Vis pour fixation planche de rive - Vite per fissare finiture davanti e dietro del tetto - Schroef voor gevellijst - Kruvi viilulauale 	68	3.5x50	
HS12	Screw for roof edge reinforcement - Schrauben für dachrandverstärkung - Vis pour fixation corniere renfort de bord de toit - Viti x rinforzo bordo tetto - Schroef voor dakrand versterking - Kruvi räästatugevdusele 	26	4x40	
HS18	Screw for rafter - Schrauben für dachsparren - Vis pour chevron - Vite per trave - Schroef voor dakspar - Kruvi sarikatele 	14	5x120	
HS18	Screw for gable - Schrauben für giebel - Vis pour fixation des pignons - Viti per timpano - Schroef voor gevelpunt - Kruvi viilude kinnitamiseks 	4	5x120	
HS16	Screw for 1. wall beam - Schraube für 1. bohlenreihe - Vis de fixations 1ere rangée de madriers avec poutrelles de fondations - Vite fissaggio alle fondamenta - Schroef voor 1 wandbalk - Kruvi poollauale 	10	5x90	
HS16	Screw for foundation - Schrauben zur befestigung fundament - Vis de fixations des poutrelles de fondations - Viti x fondamenta - Schroef voor fundering - Kruvi alusraamile 	20	5x90	
HS16	Screw for foundation - Schrauben zur befestigung fundament - Vis de fixations des poutrelles de fondations - Viti x fondamenta - Schroef voor fundering - Kruvi alusraamile 	10	5x90	
HS23	Screw for pos. 008-009; - Schrauben für pos. 008-009- Vis pour pos. 008-009 - Viti per fissare elemento vedi figura in pos. n.008-009 - Schroef voor pos. 008-009; - Kruvi pos. 008-009 	16	6x180	
NF2	Zn nail for floor fillet - Zn nägel für fussbodenleiste - Pointe pour corniere de finition du plancher - Chiodi x fissaggio pavimento - Spijker(nagel) voor vloer afdekljst - Nael põrandaliistule 	36	1.4x40	
SH44	Hammer block - Schlagholz - Calle de frappe - Blocco di legno da usare come cuscinetto quando si usa il martello - Slagklos - Löögiklots 	1		
SFS	Nut for storm protection - Schraubenmutter für sturmleiste - Ecrou pour latte anti-tempete - Dado x asta protezione vento - Moer voor stormverankering - Mutter tormikinnitusliistule 	8	D8	
NF4	Zn nail for roof - Zn nägel für dachbretter - Pointe pour fixation voliges de toit - Chiodi x perline tetto - Spijker(nagel) voor dakhout - Nael katuselauale 	556	2x50	
NF4	Zn nail for floor - Zn nägel für fussbodenbretter - Clous pour plancher - Chiodi x perline pavimento - Spijker(nagel) voor vloer - Nael põrandalauale 	512	2x50	
NF5	Zn nail for roofing felt fillet - Zn nägel für dachpappenleiste - Pointe pour baguette de fixation feutre bitumeux - Chiodi x carta bituminosa x tetto - Spijker(nagel) voor asfaltpapier afdekljst - Papiilistunael 	34	2x40	



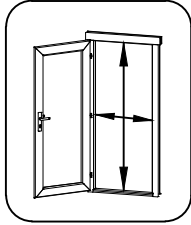
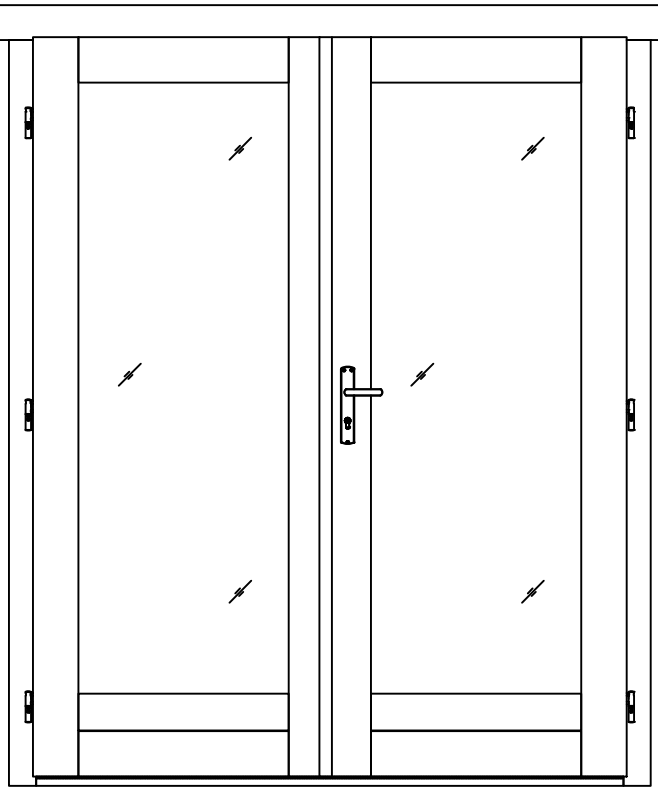
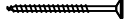
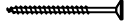
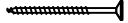

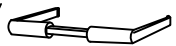
Pos	10.11.2017 Piece list - Stückliste - Liste des pièces - Elementi - Stuklijst - Tükitalabel 560x1780 AK.1.100.TPSP DGP+	1/1	Q	P (mm)	L (mm)
	<p data-bbox="256 152 1289 183">Glass size - Glasgröße - Taille de la vitre - Misura del vetro - Glas afmeting - Klaasi mõõt: 390x1602 mm</p>   <p data-bbox="1362 349 1497 380">460x1684 mm</p>				
FS2	<p data-bbox="261 2130 1023 2186">Window handle fittings - Fenstergriff - Poignee de fenetre - Maniglia c/ferramenta - Raamhendel -/grendel -/klink - Aknalink</p>		1		

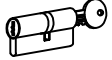
Pos	10.11.2017 Piece list - Stückliste - Liste des pièces - Elementi - Stuklijst - Tükitalabel 560x1780 AK.1.100.TPSV DGP+	1/1	Q	P (mm)	L (mm)
	<p data-bbox="256 152 1289 183">Glass size - Glasgröße - Taille de la vitre - Misura del vetro - Glas afmeting - Klaasi mõõt: 390x1602 mm</p>   <p data-bbox="1362 349 1497 380">460x1684 mm</p>				
FS2	<p data-bbox="261 2130 1023 2186">Window handle fittings - Fenstergriff - Poignee de fenetre - Maniglia c/ferramenta - Raamhendel -/grendel -/klink - Aknalink</p>		1		

Pos	Piece list - Stückliste - Liste des pièces - Elementi - Stuklijst - Tükítabel 1588x1957 TUK.1.100.TPVP.MM DGP+	1/1	Q	P (mm)	L (mm)
	Glass size - Glasgröße - Taille de la vitre - Misura del vetro - Glas afmeting - Klaasi mõõt: 561x1593 mm			 1488x1873 mm	
					
HS4	Screw for door fillet - Schraube zur Befestigung Türleiste - Vis pour fixation baguette d'arrêt de porte - Viti per massellino della porta - Schroef voor deurlijst - Kruvi ukse kokkuvaltšiliistule		5	3x30	
HS16	Screw for door jamb - Schraube für Türrahmen - Vis de fixation partie haute avec montants du cadre de porte - Viti x fissaggio montanti porte - Schroef voor deurkozijn - Kruvi ukse lengile		4	5x90	
HS25	Screw for doorstep - Schrauben für Swelle - Vis pour fixation barre de seuil - Vite per soglia della porta - Schroef voor deurdorpel - Kruvi lävepakule		3	4.5x65	
MH	Male bolt hinge for door - Türband - Partie male de paumelle de porte - Cerniera anube x porta - Scharnier bout - Reguleeritav polthing isane		6	14x80	
HC	Covers for door hinges - Schutzkappe für Türband - Couverture de paumelle de porte - Copertura delle cerniere della porta - Afdek kap voor deurscharnier - Reguleeritava polthinge kate		12		
TL4	Door handle fittings - Türgriff - Poignée de porte - Maniglie - Deurhendel / klink - Ukse käepide		1		
TL5	Set of door lock covers - Schlossblenden - Set de garnitures de porte - Copertura serrature - Slot sluitplaat set - Ukse lukuplaat		1		
	Cylinder lock - Zylinderschloss - Barillet de porte - Serratura - Cylinder slot - Ukse lukusüdamik		1	30x35	
	Striker for barrel bolt - Hülse für Grendelriegel - Gache au sol du targette - Boccola per fermo della porta - Huls voor vergrendelingsschuif - Vasturaud ukse servariivile		2		