

Technische Daten: Art.-Nr.: 350 310

Wandaußenmaß: 413 x 210 cm

Bohlenstärke: 70 mm



Kontrolliert durch:

Achtung: Alle angegebenen Maße sind ca.-Maße!

3D-Darstellung Art.-Nr. 350 310

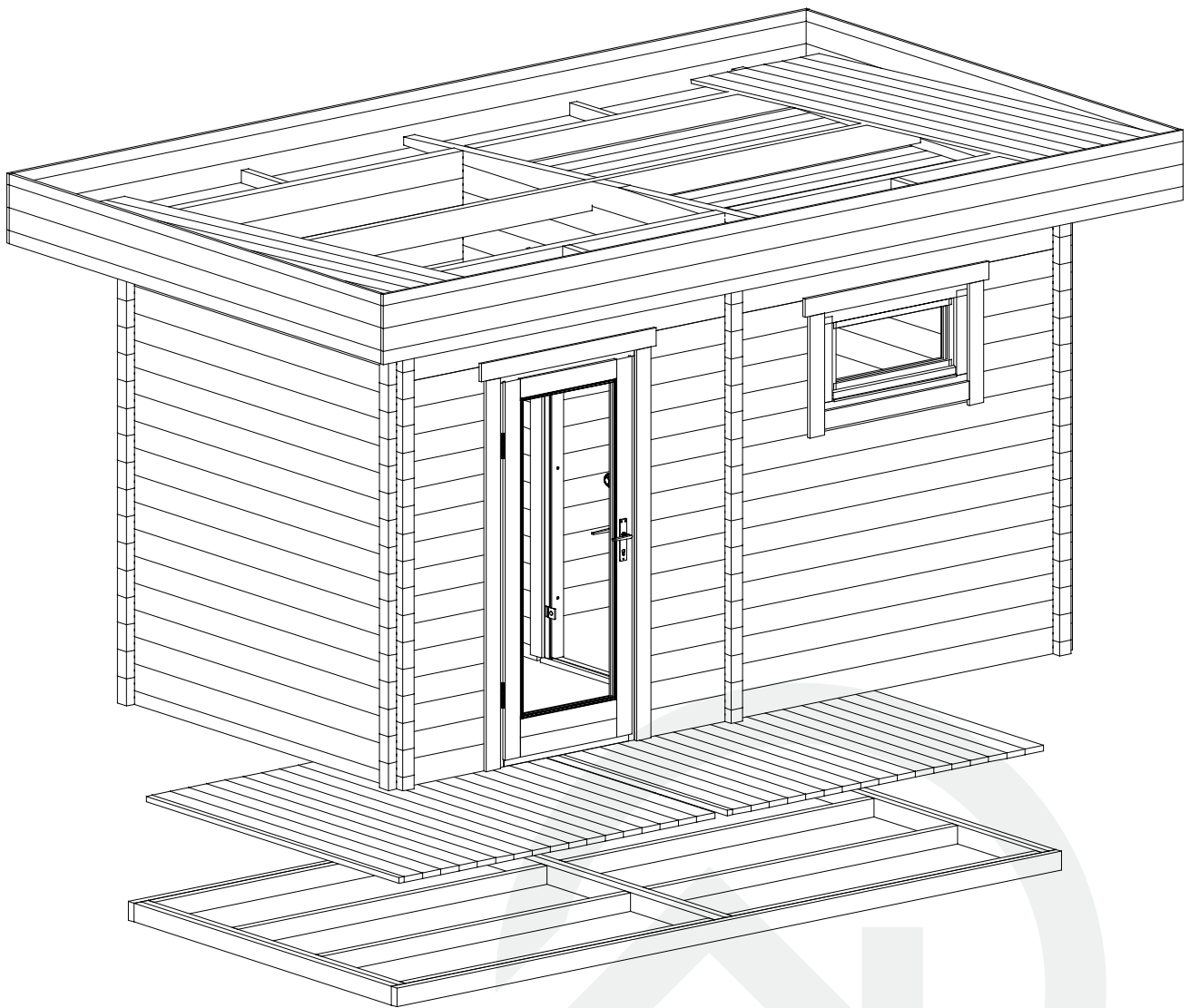

3D-Darstellung Art.-Nr. 350 310

Das Saunahaus ist
spiegelbildlich aufbaubar.

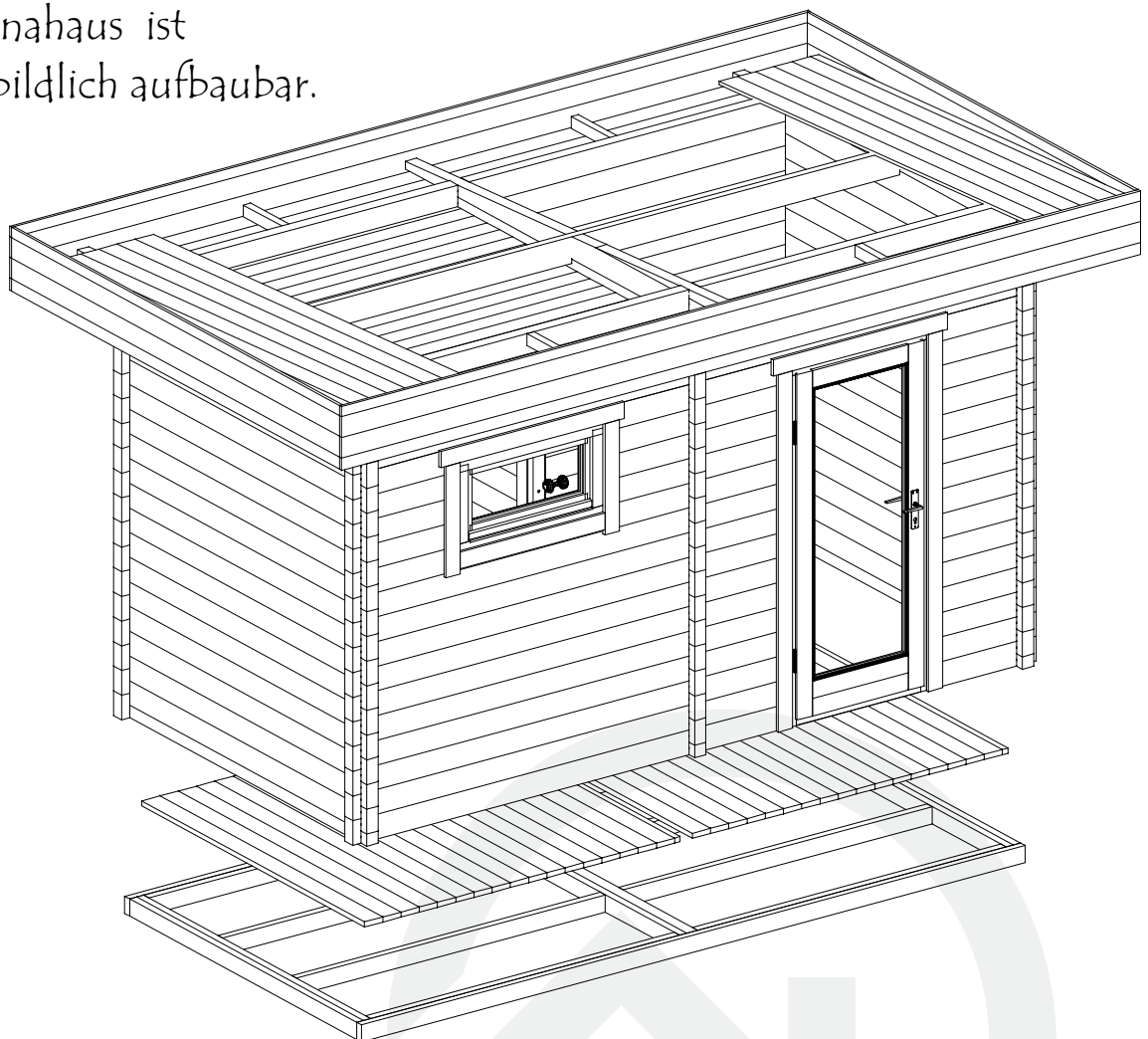

Grundriss

Art.-Nr. 350 310

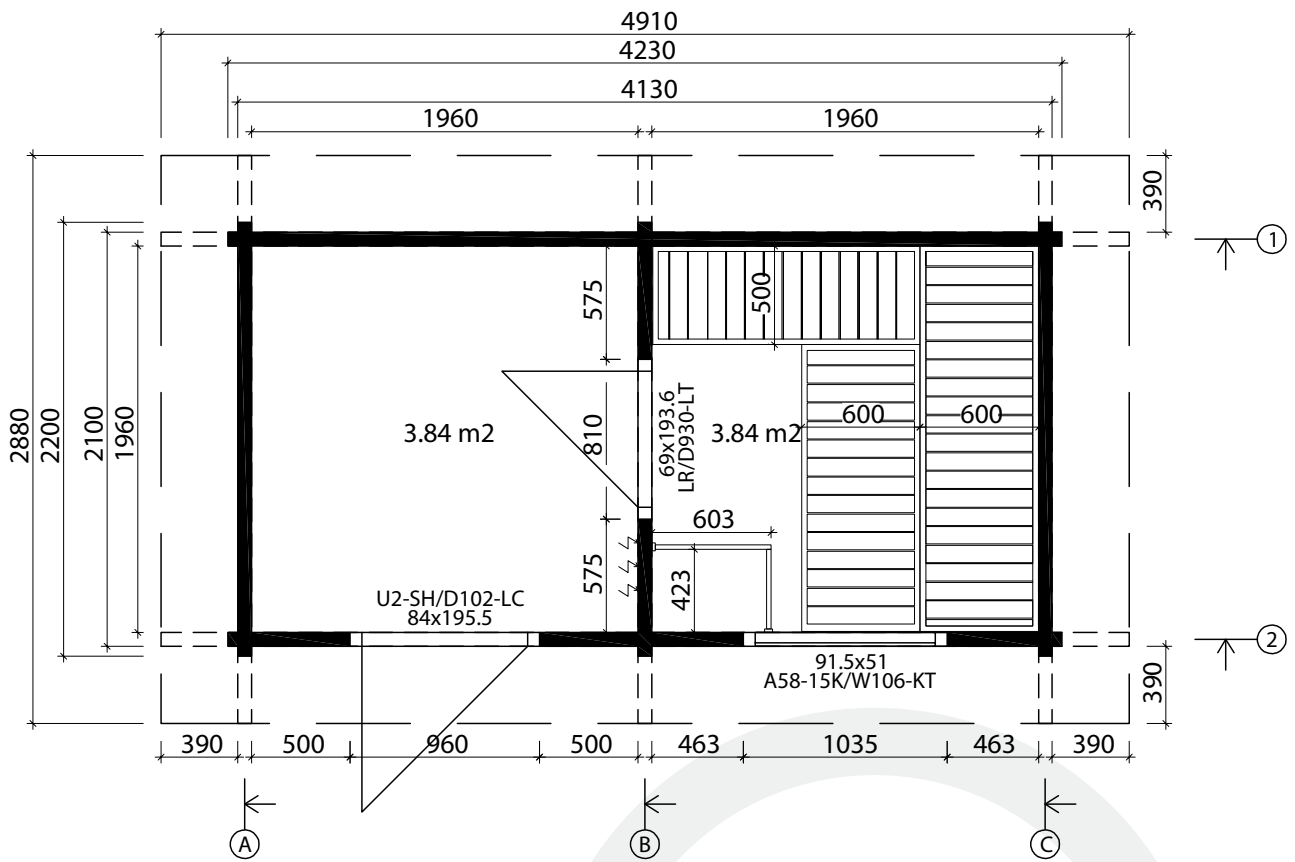

↙ - Bohrung für elektrische Kabel

Q5-Qualitätsklasse für Fenster und Türen

Grundriss

Art.-Nr. 350 310

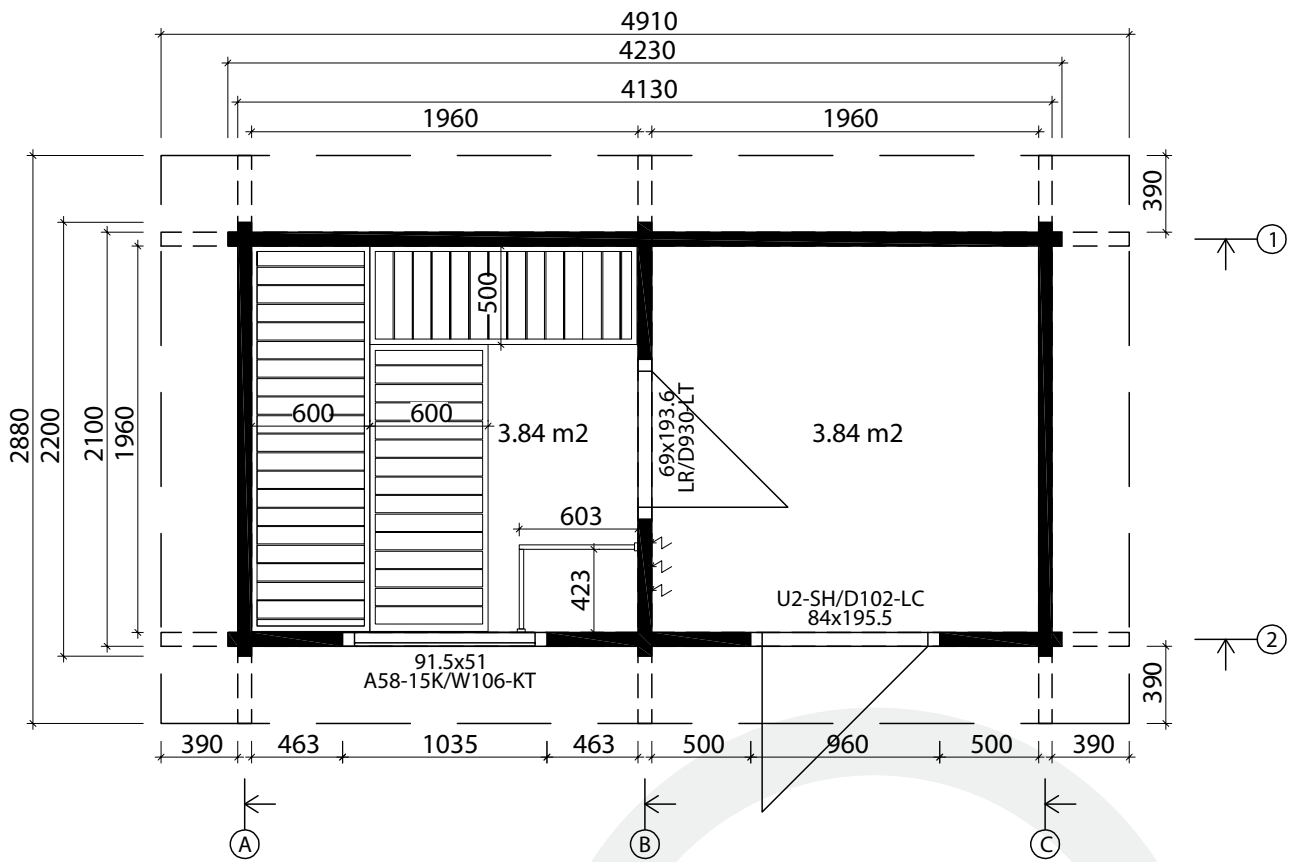

↖ - Bohrung für elektrische Kabel

Q5-Qualitätsklasse für Fenster und Türen





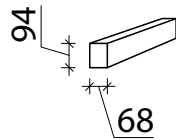
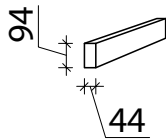
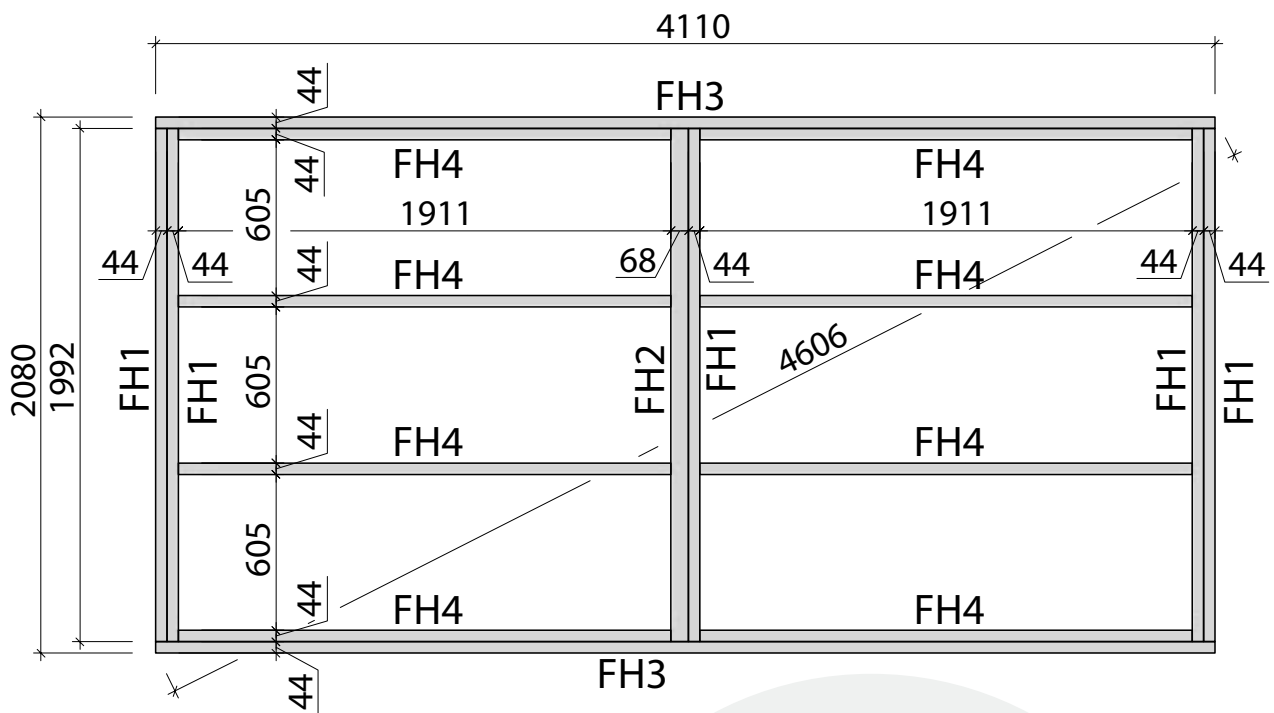





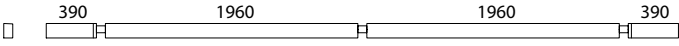
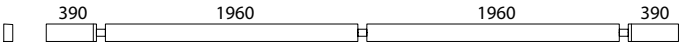

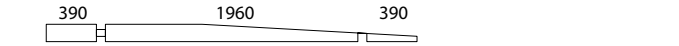
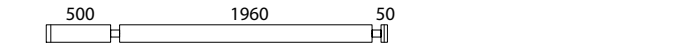
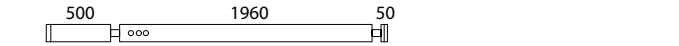
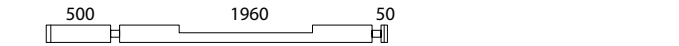
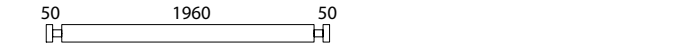
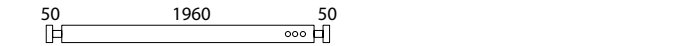
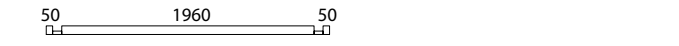
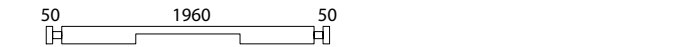



Lagerholzplan und Fundamentplan Art.-Nr. 350 310

Wir empfehlen als Fundament für Ihr Gartenhaus eine vollflächig festgegründete, gepflasterte oder betonierte Fläche.
Wahlweise ist auch ein Punkt- oder Streifenfundament möglich.



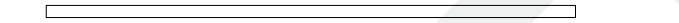



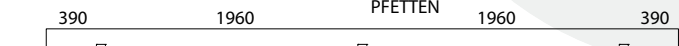









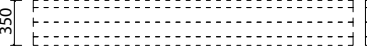



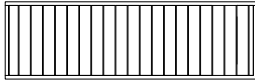
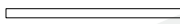

Teileliste 1

Art.-Nr. 350 310

Pos		Stck	Profil (mm)	Länge (mm)
001		1	70x113	4910
002		1	70x135	4910
003		20	70x135	4230
004		3	70x135	2880
005		9	70x135	2650
006		1	70x135	2650
007		1	70x135	2650
008		34	70x135	2200
009		2	70x135	2200
010		2	70x68	2200
011		1	70x135	2200
012		3	70x68	1210
013		4	70x135	1033
014		1	70x68	695
015		13	70x135	695
016		15	70x135	695
017		1	70x68	695
018		15	70x135	620
019		4	70x135	583
FH2	FUNDAMENTHÖLZER (imprägniert) 	1	68x94	1992
FH3	FUNDAMENTHÖLZER (imprägniert) 	2	44x94	4110
FH1	FUNDAMENTHÖLZER (imprägniert) 	5	44x94	1992
FH4	FUNDAMENTHÖLZER (imprägniert) 	8	44x94	1911
HS1	HOLZSCHWELLE (unter der Saunatur) 	✓ 1	75x28	750
PF1	PFETTEN 	1	44x145	4910



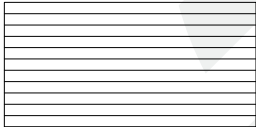
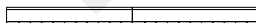









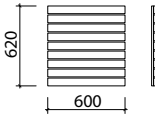

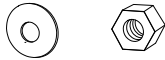

Teileliste 2

Art.-Nr. 350 310

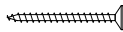
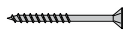
Pos		Stck	Profil (mm)	Länge (mm)
	DACHBRETTER  oder 	44+1 56+1	113x18 88x18	2785
	FUSSBODENBRETTER 	36+1	113x28	1955
	ABDECKLEISTEN  ✓		15x28	16,0 lfm
	FUSSBODENLEISTE  ✓		14x55	16,0 lfm
BL-1	DACHBLENDEN 350mm  350	2	18x350	2884
BL-2	DACHBLENDEN 350mm  350	2	18x350	4946
BS-1	DACHBLENDEN- Blendenstützen 44x65 	4	44x65	390
UPB-1	DACHBLENDEN- U-Profil für Blenden  40 ✓		65x44	16,0 lfm
DPL-1	DACHPAPPENLEISTE 15x28  ✓		15x28	11,0 lfm
T4-1	TRAUFELEISTE 40x18  ✓		40x18	10,0 lfm
TL3-1	T-LEISTE 70 	2	70x45	490
TL3-2	T-LEISTE 70 	2	70x45	1908
TL3-3	T-LEISTE 70 	2	70x45	1975
	SAUNABANK /Espe/ 60 cm/50 cm 	2	ca 600x90	1955
		1	ca 500x90	1355
	TRÄGELEISTE FÜR SAUNABÄNKE 	3	ca 30x40	600
	TRÄGELEISTE FÜR SAUNABÄNKE 	2	ca 30x40	1200
	STÜTZPFOSTEN FÜR SAUNABÄNKE  ✓	1	44x68	500
	STÜTZPFOSTEN FÜR SAUNABÄNKE  ✓	2	44x68	1000
	RÜCKLEHNE /Espe/ 	2	ca 250x39	1860
	BÄNKE ZWISCHENSTÜCK /Espe/ 	1	ca 300x39	1955
	DECKENISOLATION  	2 Elemente	ca 1950x975	
	TRÄGELEISTE FÜR DECKENISOLATION  ✓	4	35x35	2000

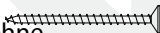
Teileliste 3

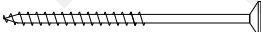
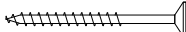
Art.-Nr. 350 310

Pos		Stck	Profil (mm)	Länge (mm)
	KOPFSTÜTZE /Espe/ 	2	ca 444x300	
	HEIZUNG UMBAU 		2 Elemente	
	LUFTSCHIEBER 	3		
	BODENROST /Fichte/ 	1	600x620	
SH	Schlaghölzer 	3		
KL1	Gewindestange M8 	4	M8	2000
KL2	Gewindestange M8 	2	M8	573
KL3	Gewindestange M8 	2	M8	460
	Mutter M8 U-Scheibe Ø25 	8	M8	
	Befestigungsmutter M8 	4	M8	
	Schlossschraube 70mm für Verbinden der Saunabänke 600+500mm in der Ecke	2	M8	
NG3	DACHPAPPNÄGEL 2.0x18 	300		
NG1	NÄGEL 2.5x50 Dachbretter 	264 340	113x18 oder 88x18	
SR01	SCHRAUBEN 3.0x30 Abdeckleisten, Fussbodenleisten Dachpappenleisten, Traufenleisten 40x18 Bänke Zwischenstück, Luftschieber 	124		
SR37	SCHRAUBEN 3.5x45 Heizung Umbau 	8		
SR3 550	SCHRAUBEN 3.5x45 C3 Fenster- und Türleisten 	64		
SR3 550	SCHRAUBEN 3.5x45 C3 U-Profil 	32		
SR44	SCHRAUBEN 4.0x60 Trägleiste für Saunabänke Trägleiste für Deckenisolation, Rücklehne 	62		
SR4 210	SCHRAUBEN 4.2x55 C2 28mm Fussbodenbretter, Holzschwelle 	148		
SR57	SCHRAUBEN 5.0x100 Fundamenthölzer Stützpfeiler für Saunabänke 	70		
SR55	SCHRAUBEN 5.0x70 Blendenbefestigung 	50		
	Dichtungsband für Deckenisolationselemente 			ca 8,0 lfm

Teileliste 4

Art.-Nr. 350 310

Pos		Stck	Profil (mm)	Länge (mm)
	DACHPAPPE ✓		5,6m-4st.	23,0 lfm
	FENSTER Q4 W4-S70K-0XT-09150510 A58-15K/W106-KT L1 18x90 L=1155mm 2x L2 18x90 L=630mm 4x L3 18x90 L=915mm 2x ✓ Gehärtete Glas	1		
	TÜR D0-L70L-0XT-06901936 LR/D930-LT L1 18x90 L=930mm 2x L2 18x90 L=1936mm 4x ✓ DIN links	1		
	TÜR Q4 D4-S70L-0XC-08401955 U2-SH/D102-LC L1 18x90 L=1080mm 2x L2 18x90 L=1955mm 4x ✓ DIN links	1		
	✓ - Bitte selber anpassen (falls nötig)! / Cut into length on site (if needed)!			

Detailzeichnung

Art.-Nr. 350 310

Montageanleitung für T-leisten / Installing the door and window supports / Tenderliistu paigaldusjuhend.

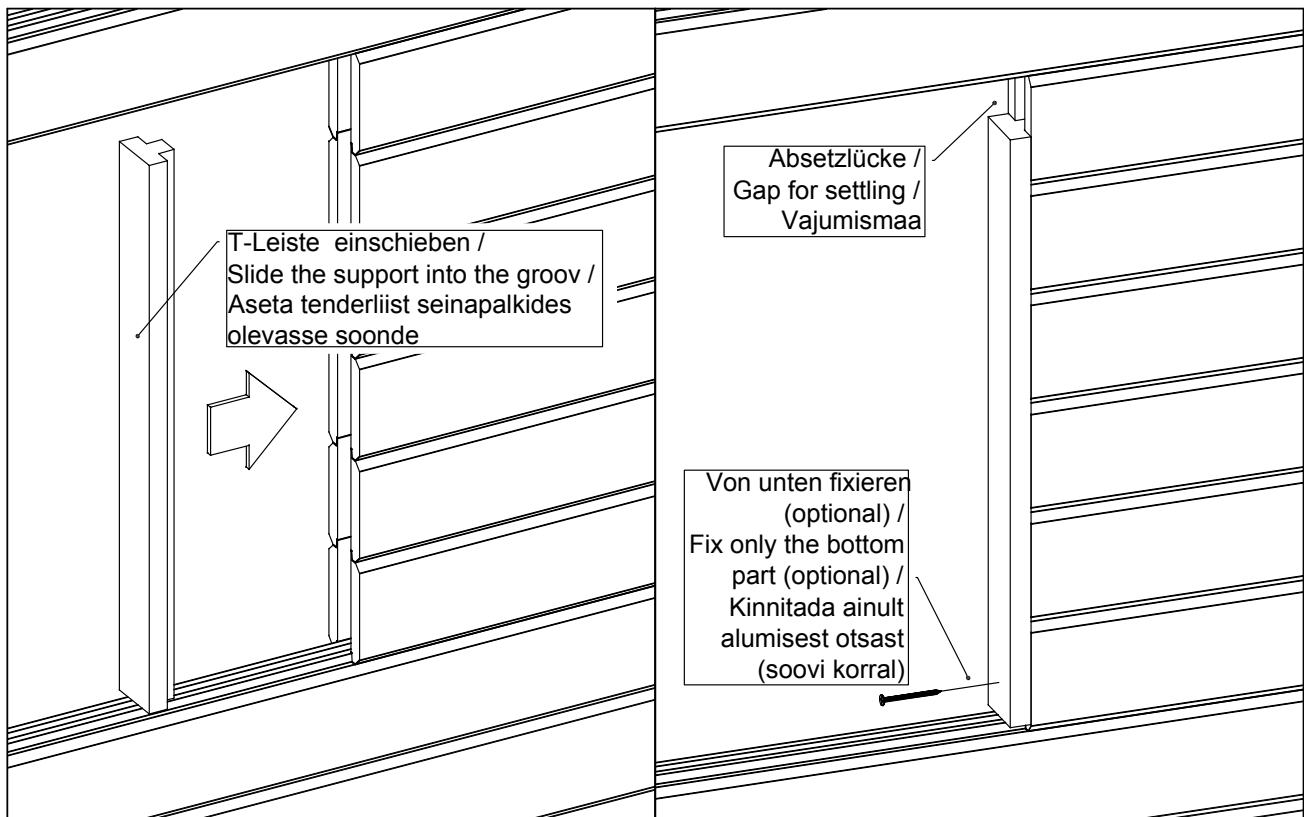

Detailzeichnung Art.-Nr. 350 310

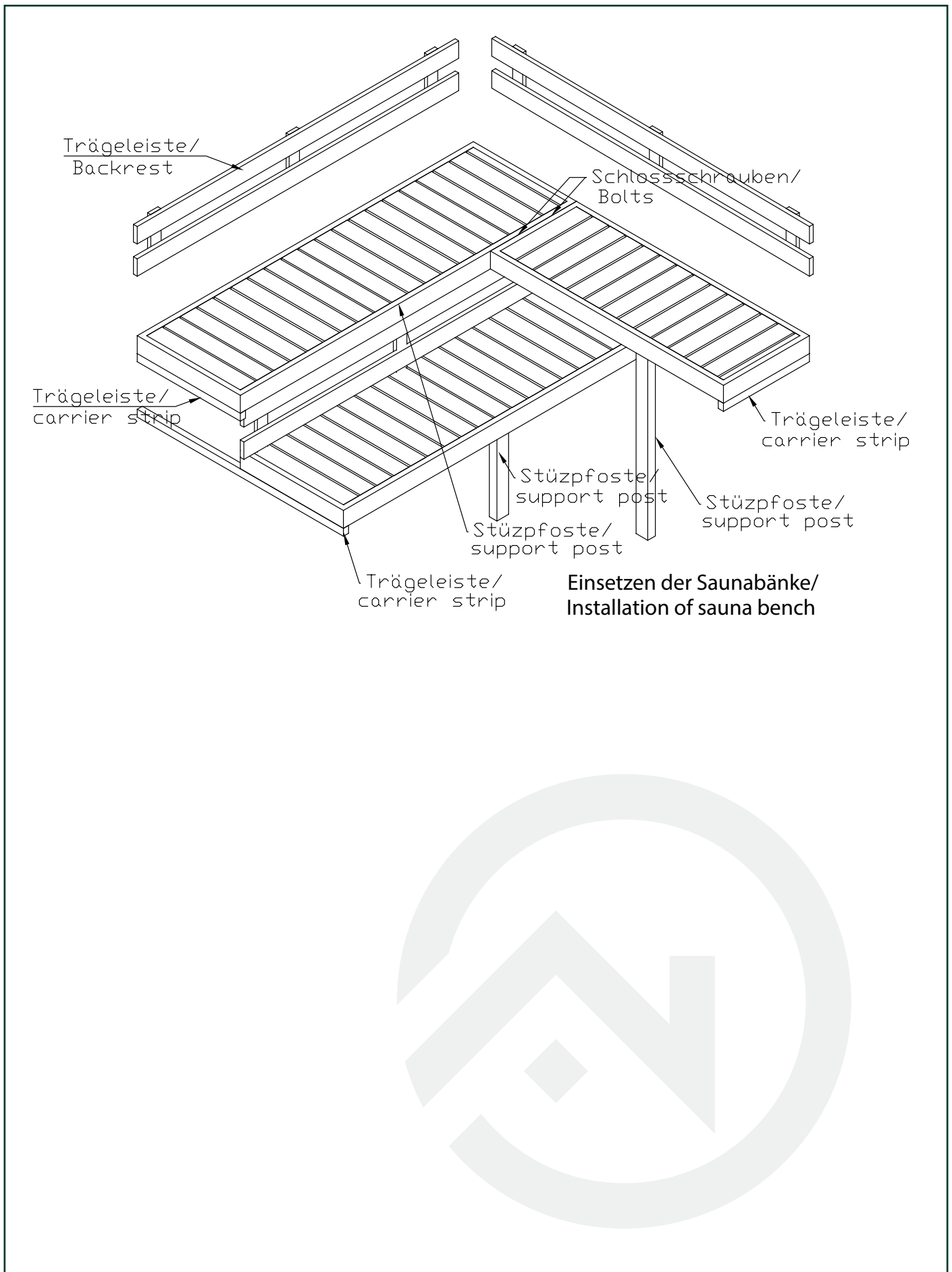

Detailzeichnung Art.-Nr. 350 310

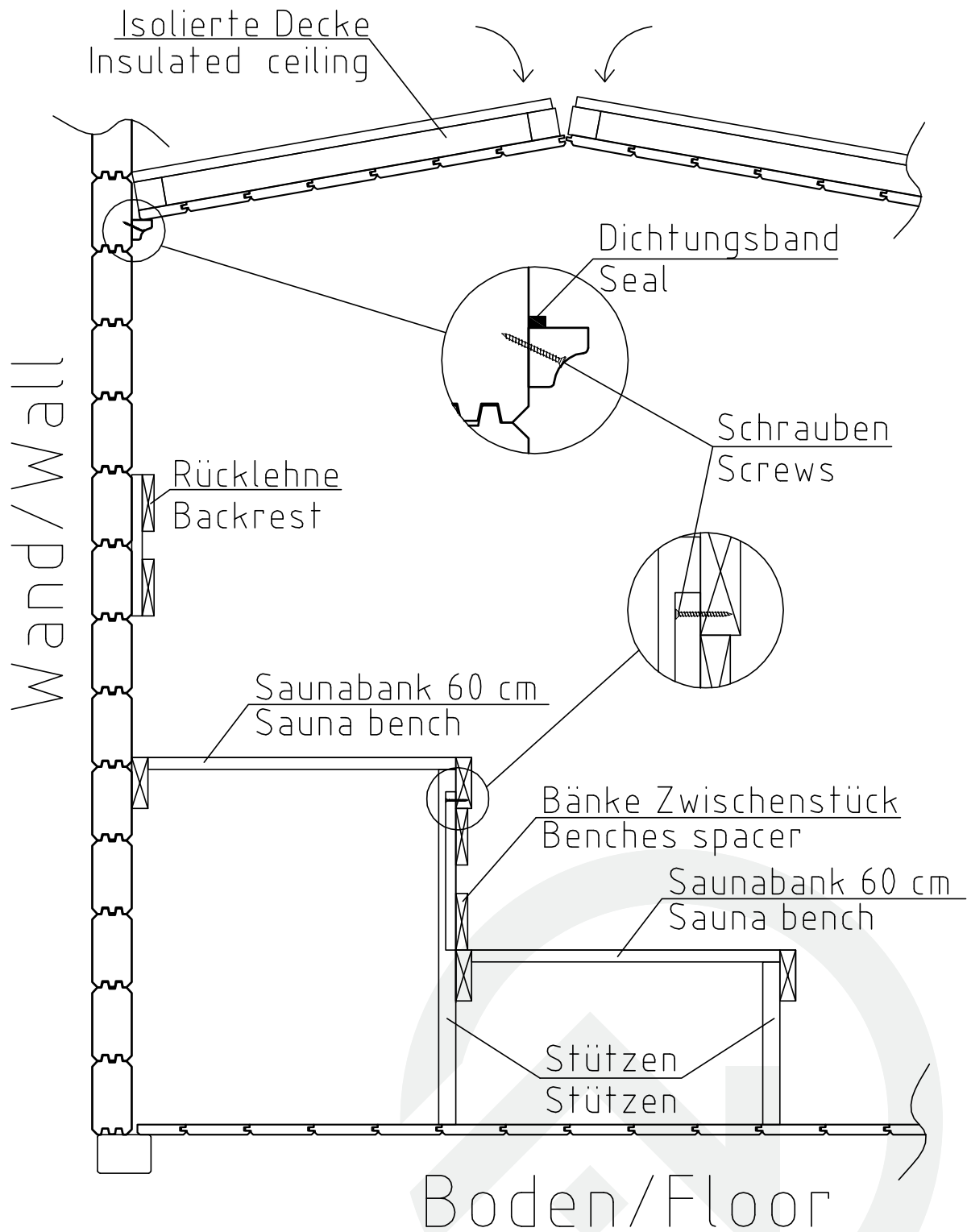

Montage Bänke und Zwischen Decke/
Installation of sauna furniture

Schnitt / Section

Wandplan 1

Art.-Nr. 350 310

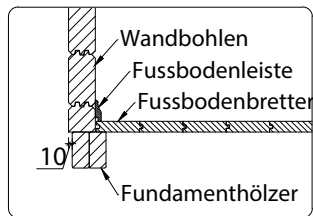
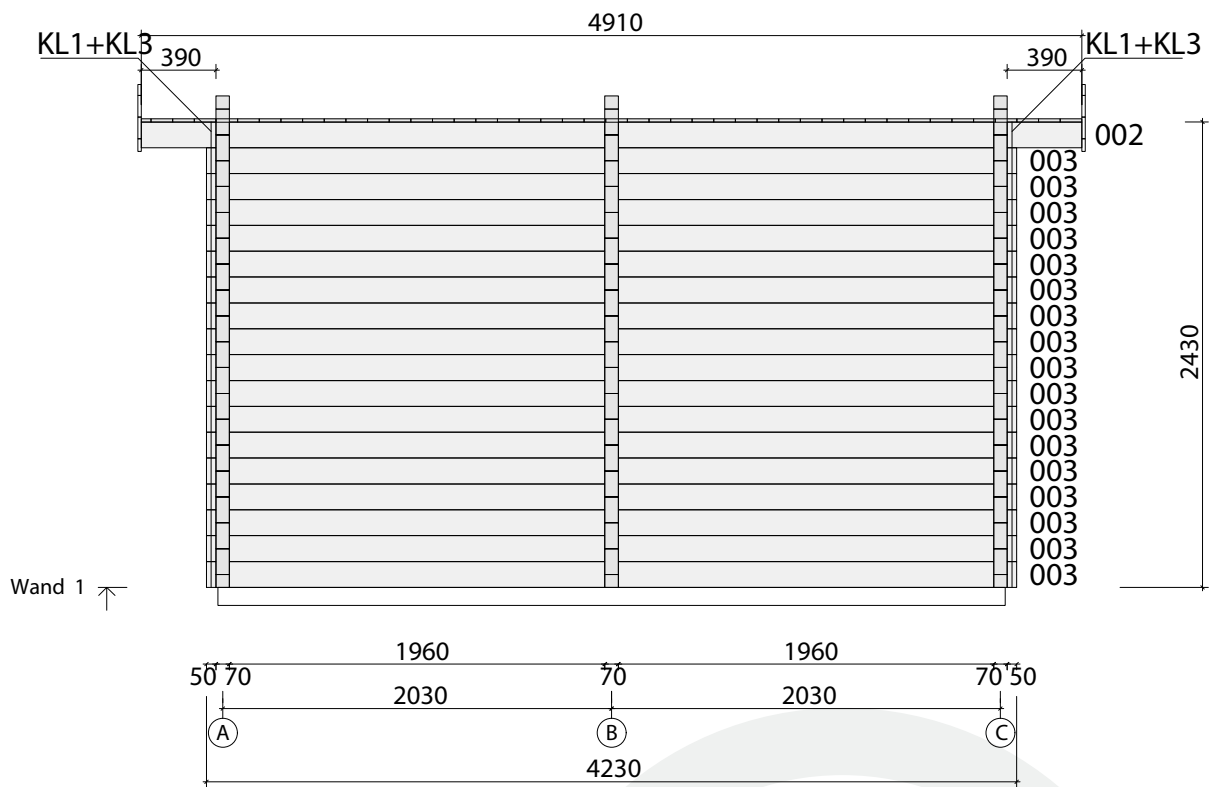

Wandplan 2

Art.-Nr. 350 310

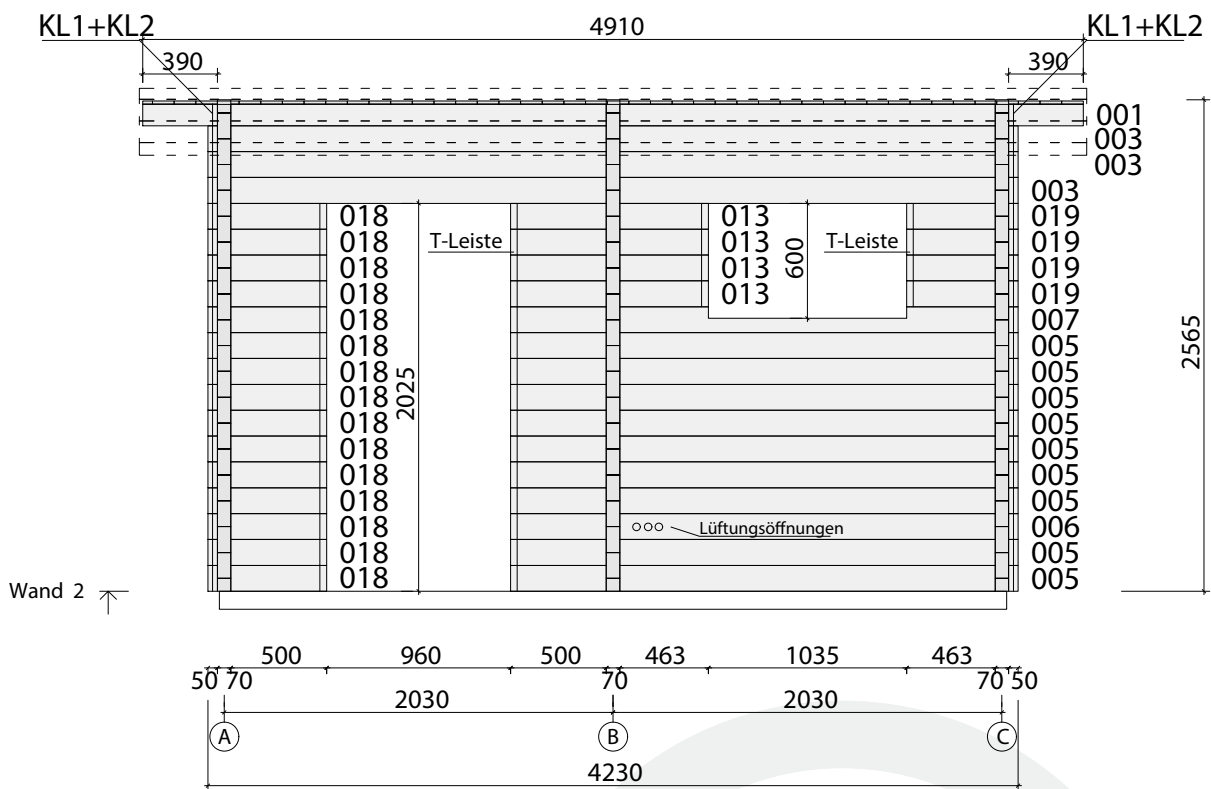

Die Bohlen mit Lüftungsöffnungen können je nach Bedarf höher oder niedriger eingesetzt werden. Bitte achten Sie darauf, dass die Lüftungsöffnungen von innen nicht mit der Saunabank bedeckt werden!

Wandplan A

Art.-Nr. 350 310

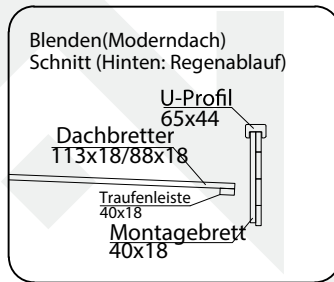
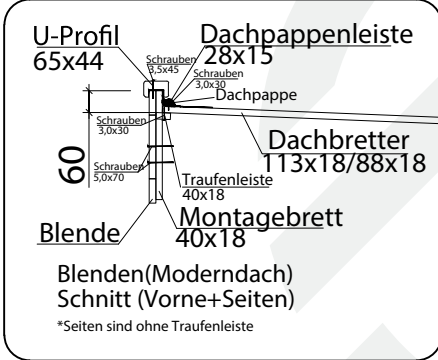
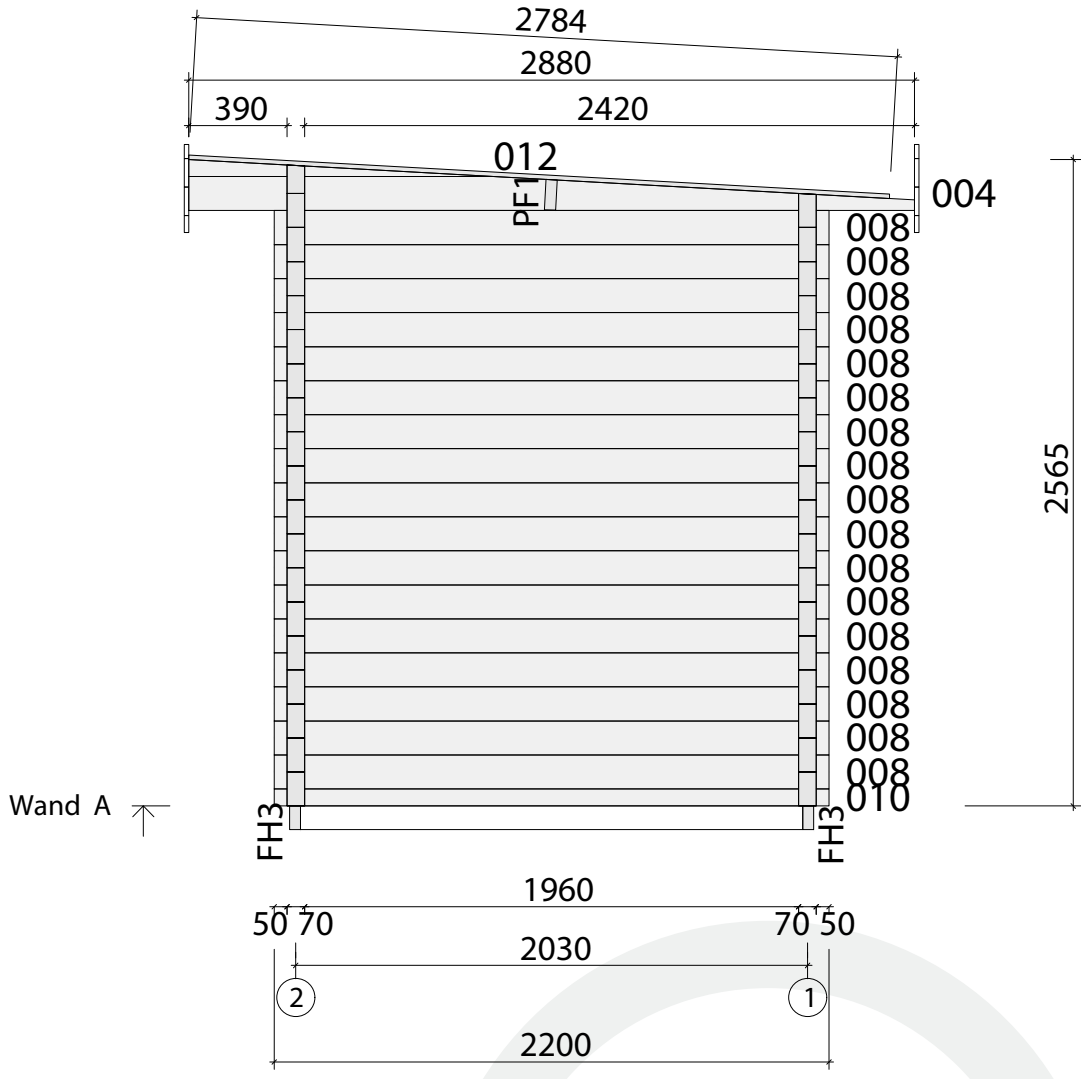

Wandplan B Art.-Nr. 350 310

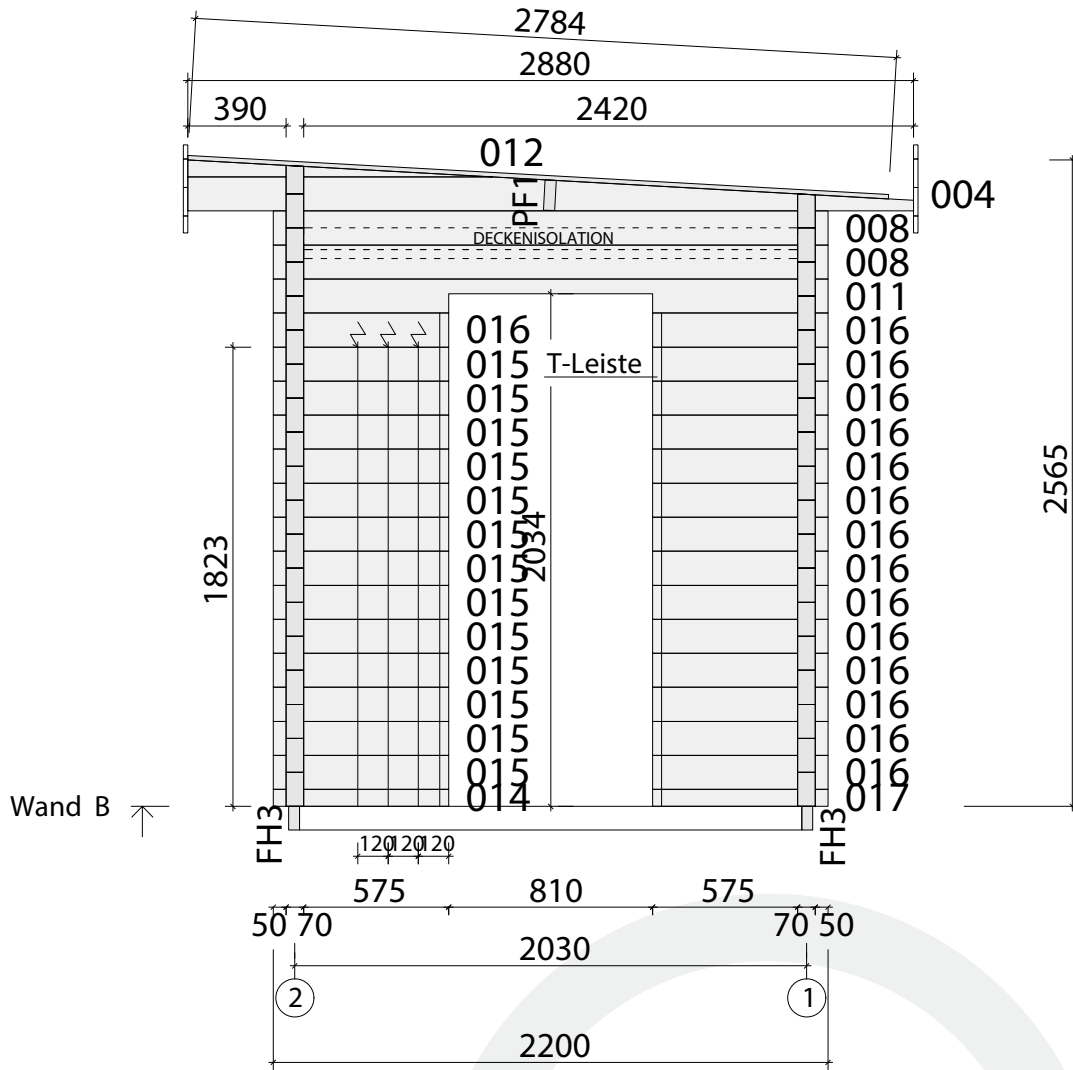

↗ -Bohrung für elektrische Kabel

Wandplan C

Art.-Nr. 350 310

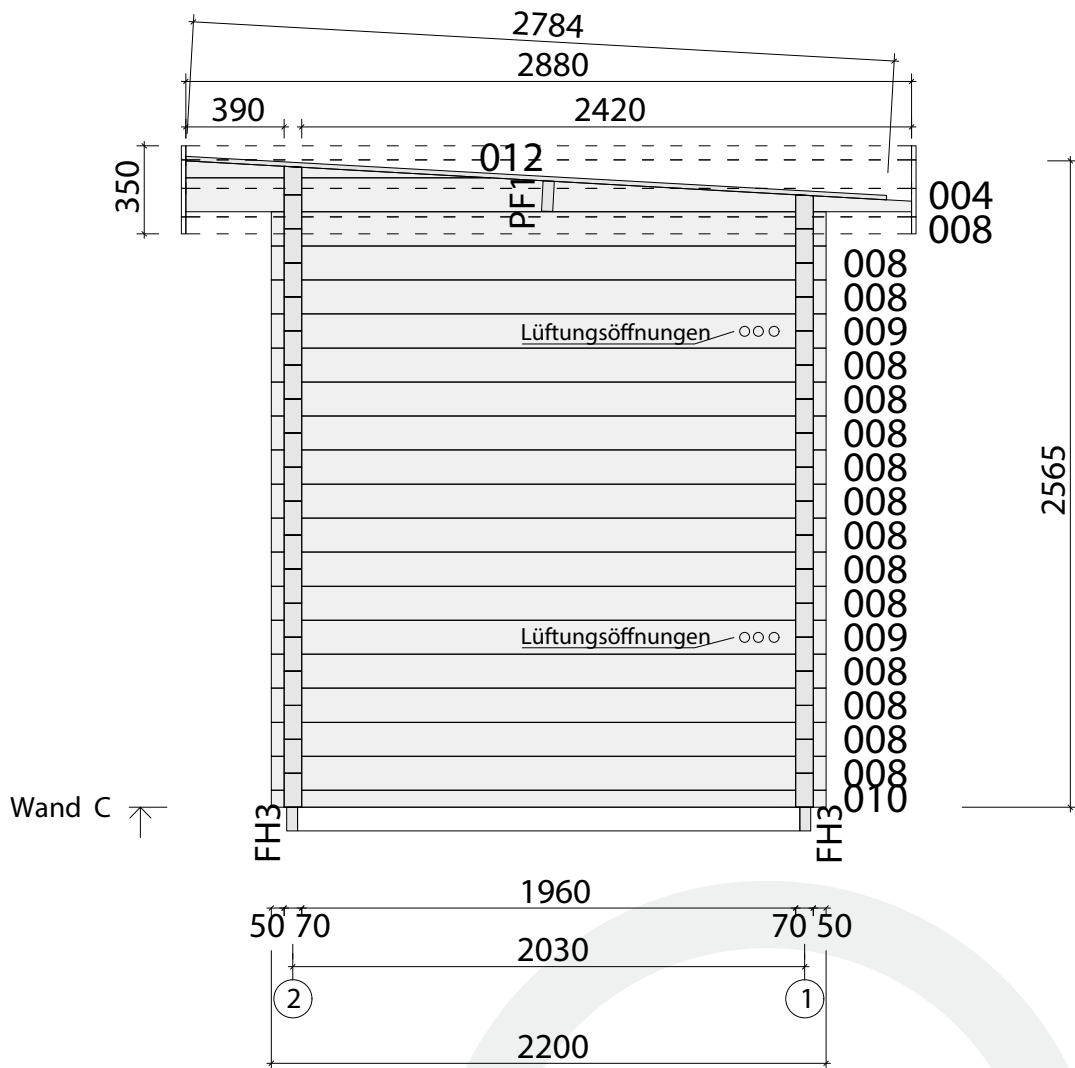

Die Bohlen mit Lüftungsöffnungen können je nach Bedarf höher oder niedriger eingesetzt werden. Bitte achten Sie darauf, dass die Lüftungsöffnungen von innen nicht mit der Saunabank bedeckt werden!

Türmontage

Art.-Nr. 350 310

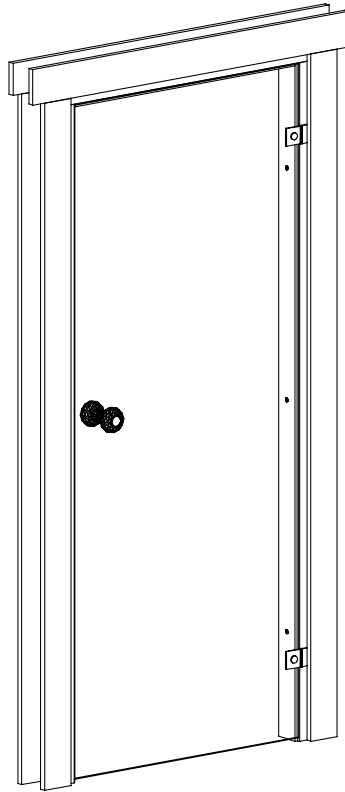

18x90 Blendleisten/
cover strips/piirdeliistud

Rahmenleisten
20x Wandstärke/
frame extensions
20x wall thickness/
laiendusliist
20x seina paksus

18x90 Blendleisten/
cover strips/piirdeliistud

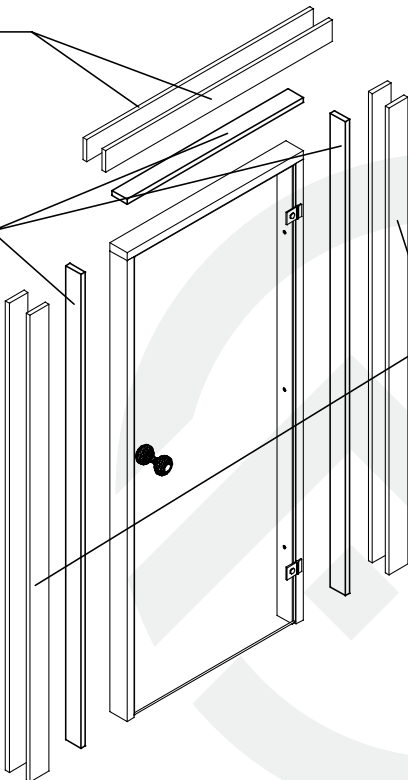

Türmontage

Art.-Nr. 350 310

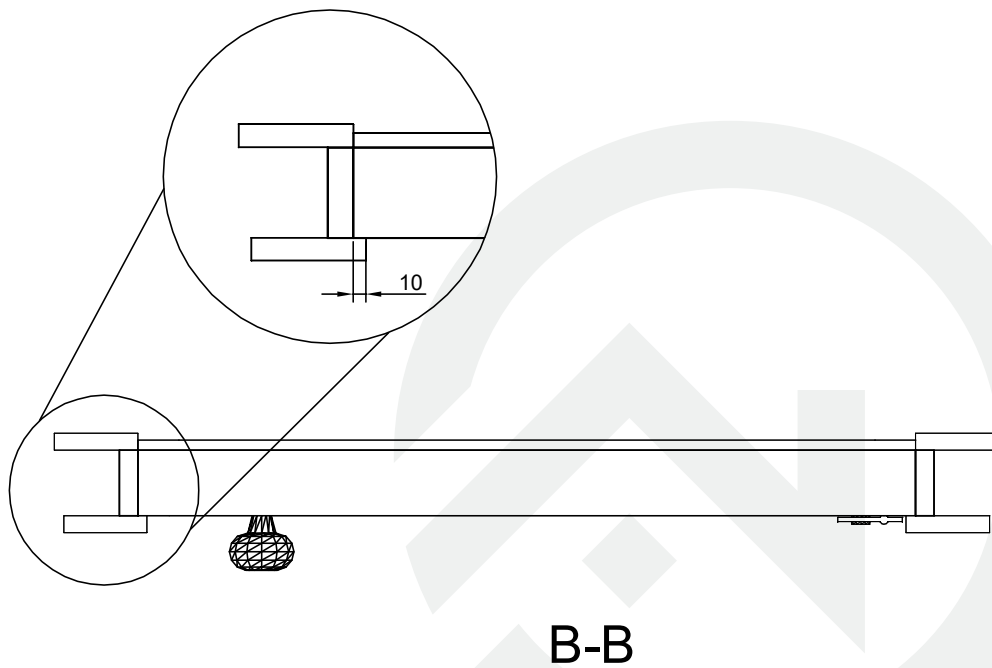
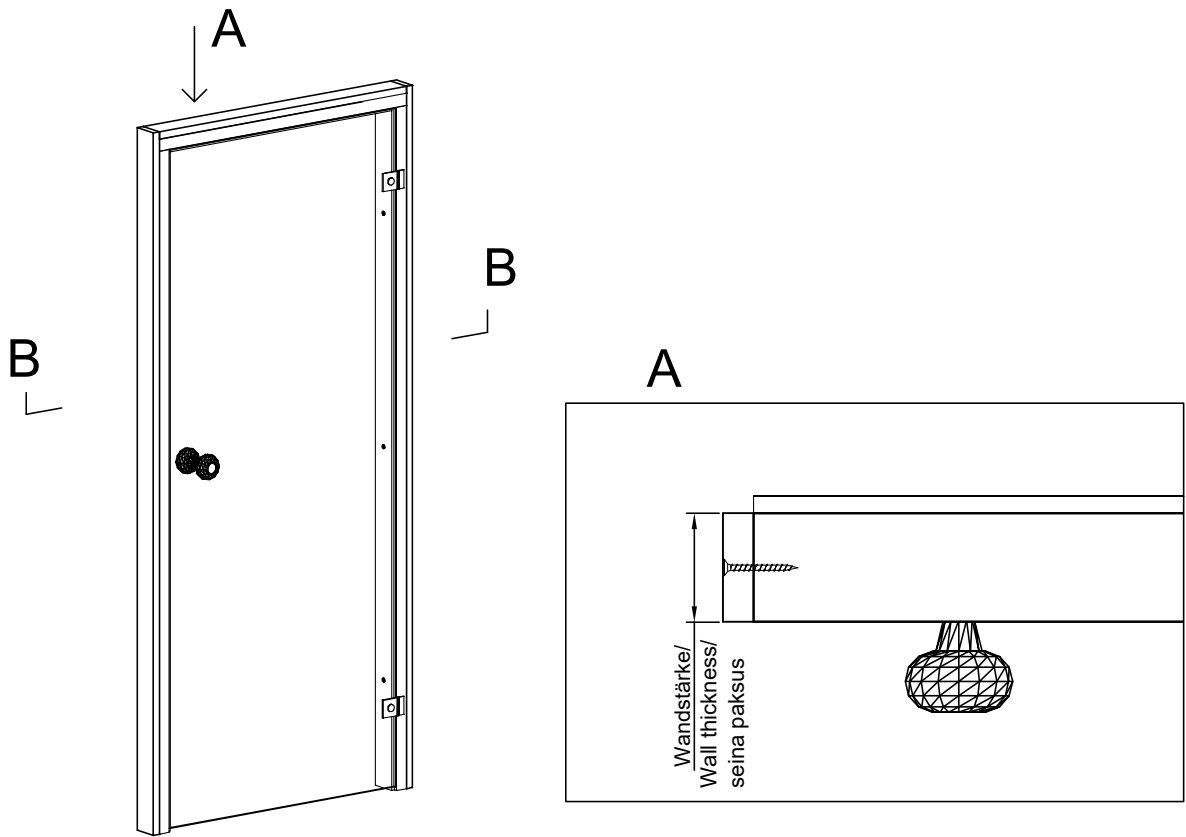

Türmontage

Art.-Nr. 350 310

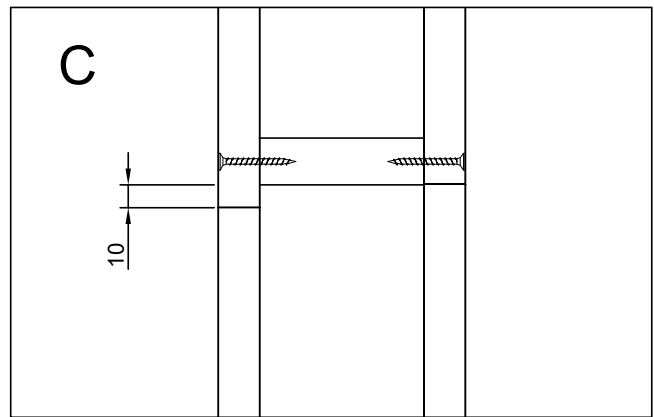
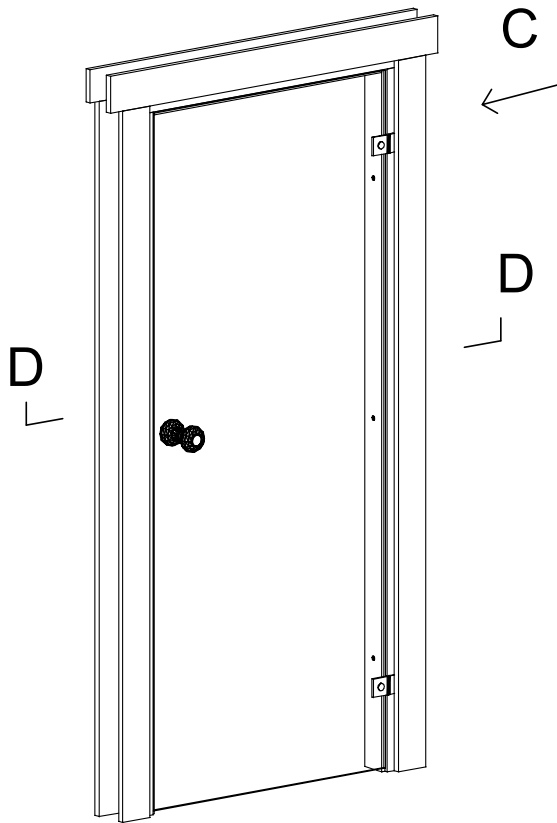

D-D

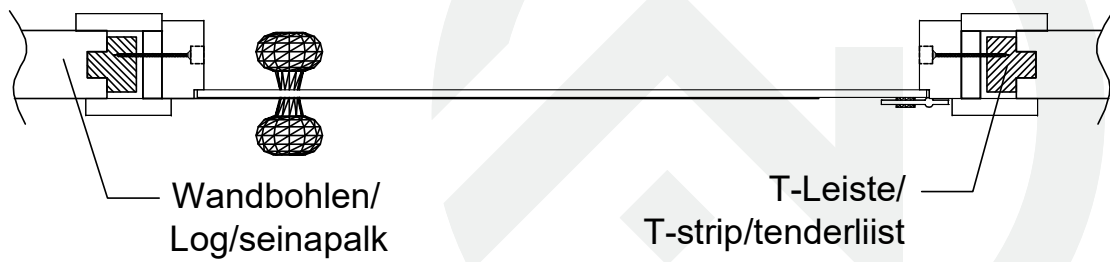

Fenstermontage

Art.-Nr. 350 310

Akna tüüp / Fenster typ / Window type - A68
(GH+ / SH)

