

Bingham 1
Art. Nr. 4427240
1/7

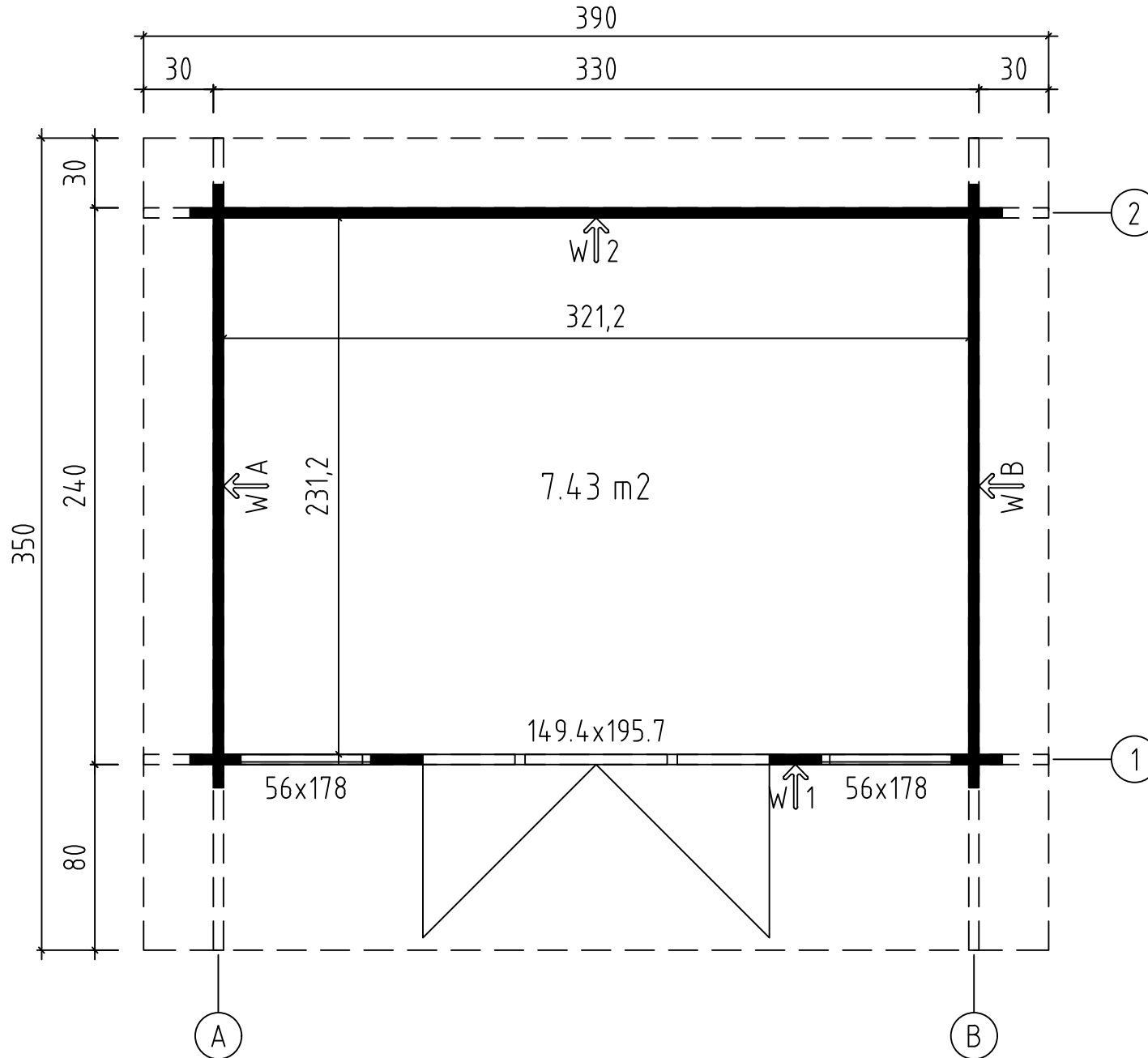

19.02.2021

Art.Nr. 4427240
Groundplan - Grundplan - Plan de masse - Planimetria - Plattegrond - Põhiplaan



Art.Nr. 4427240

Foundation - Fundament - Fondation -
Fondamenta -Fundering - Immutatud alusraam

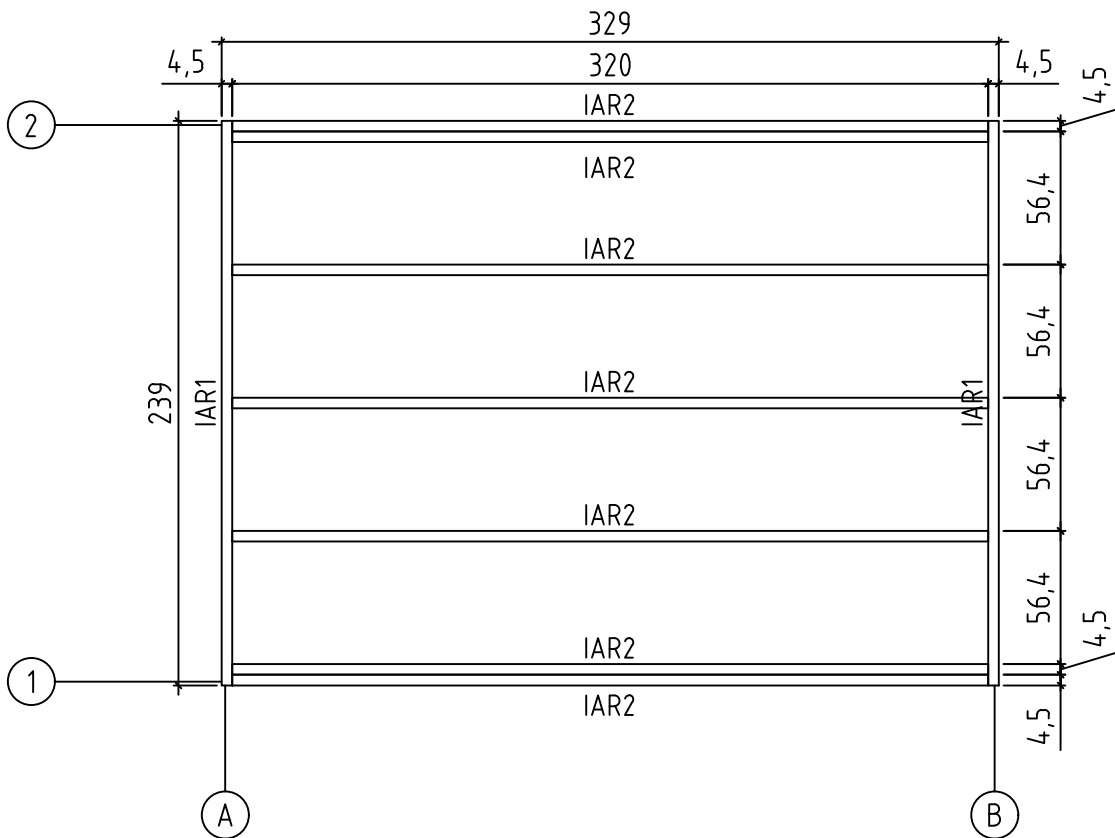



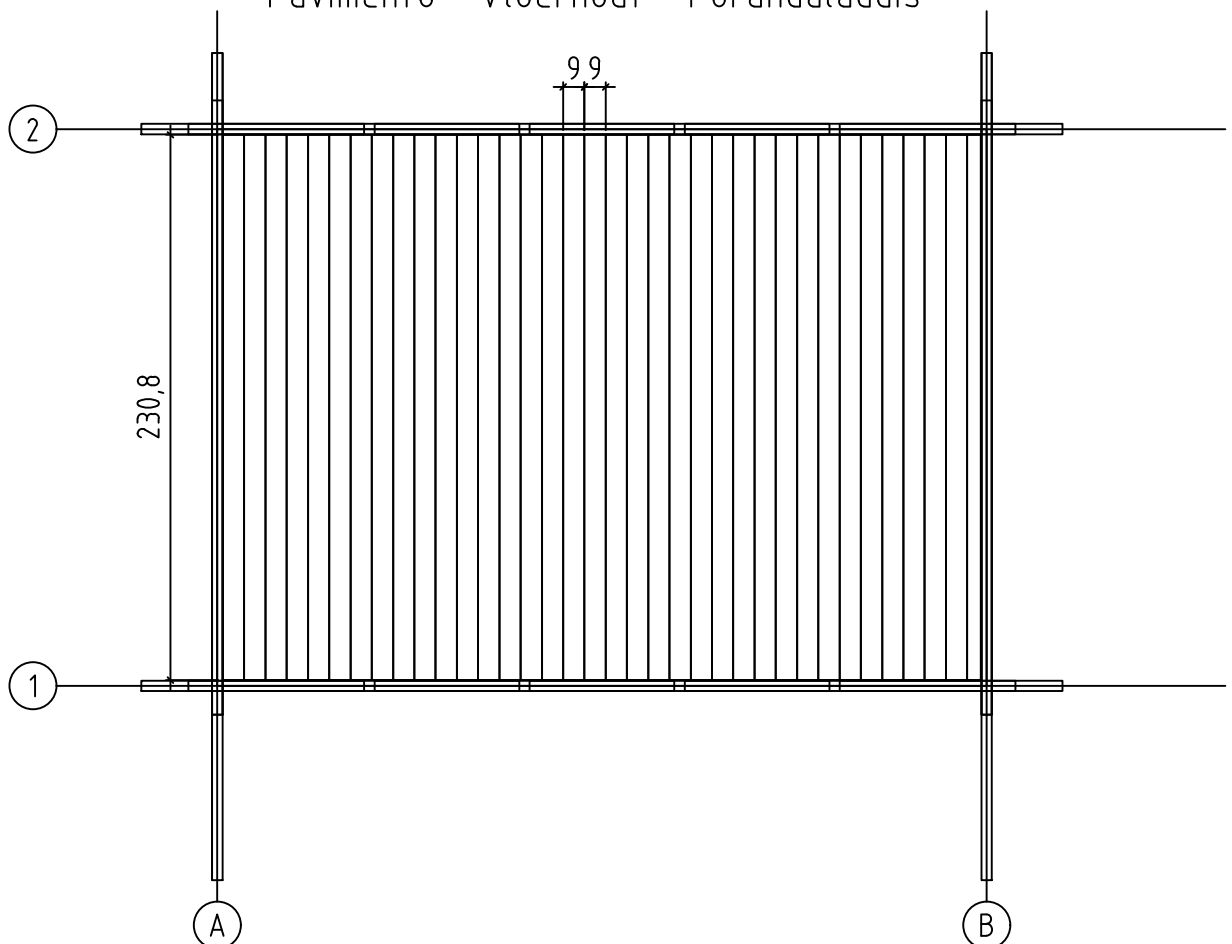

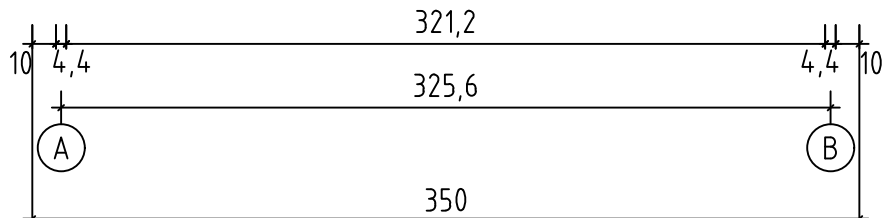
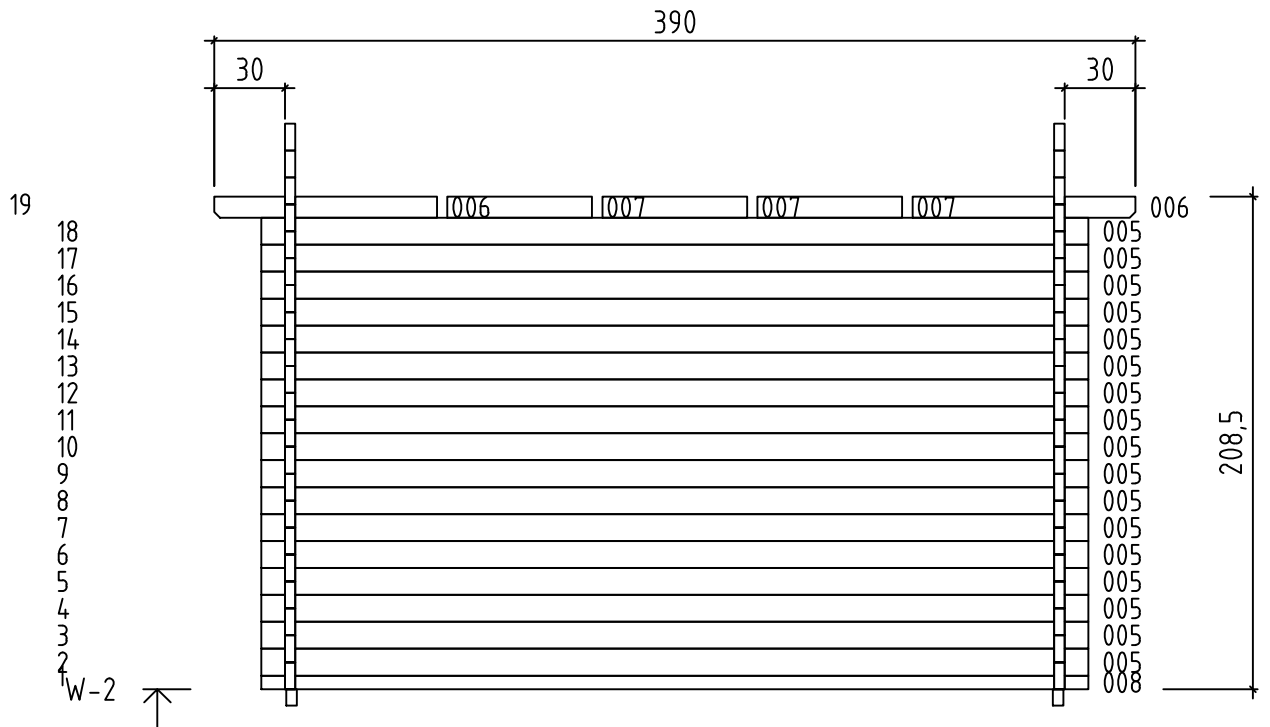
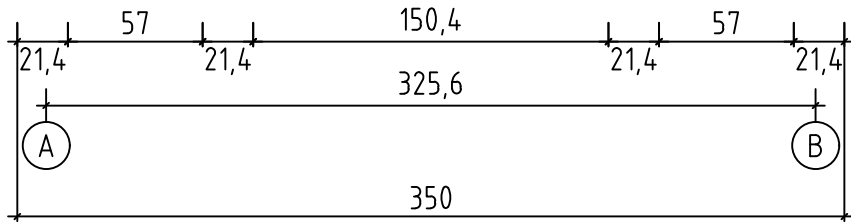
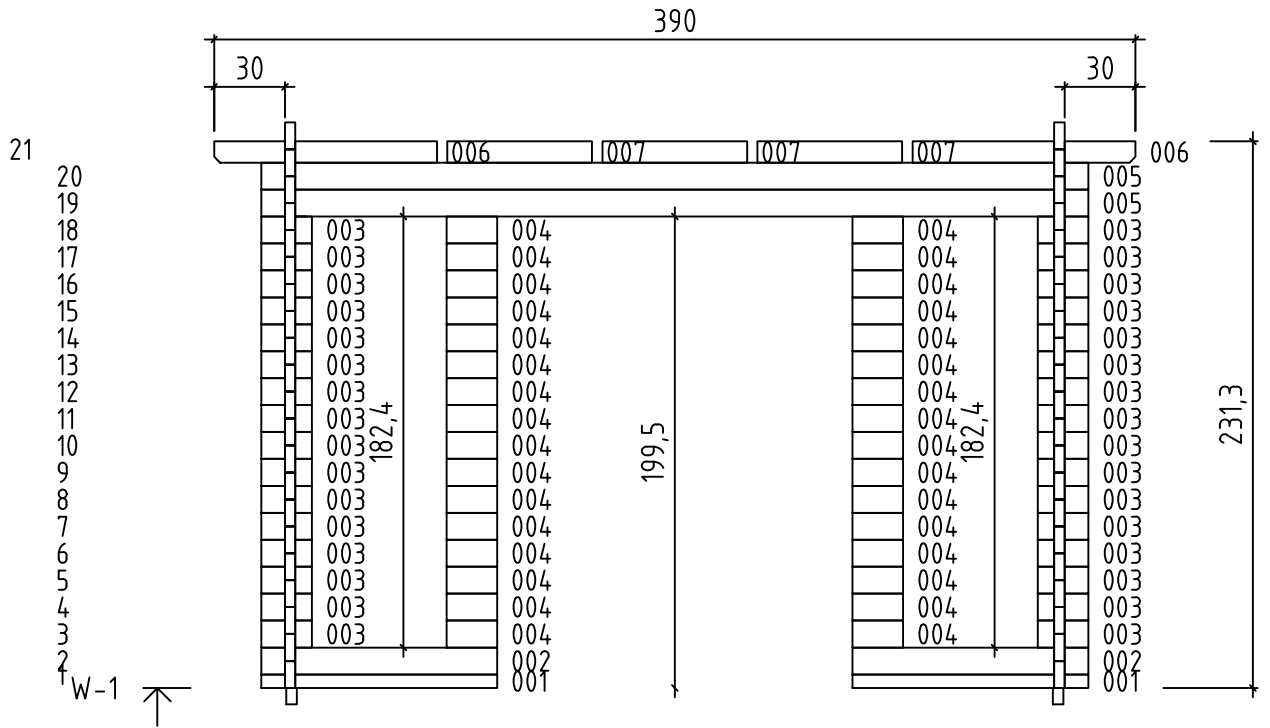

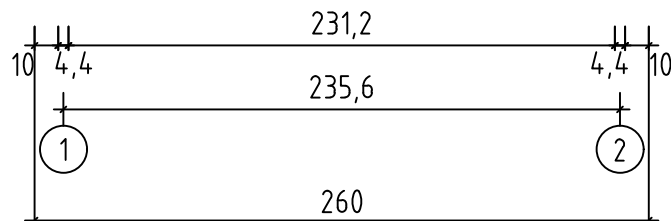
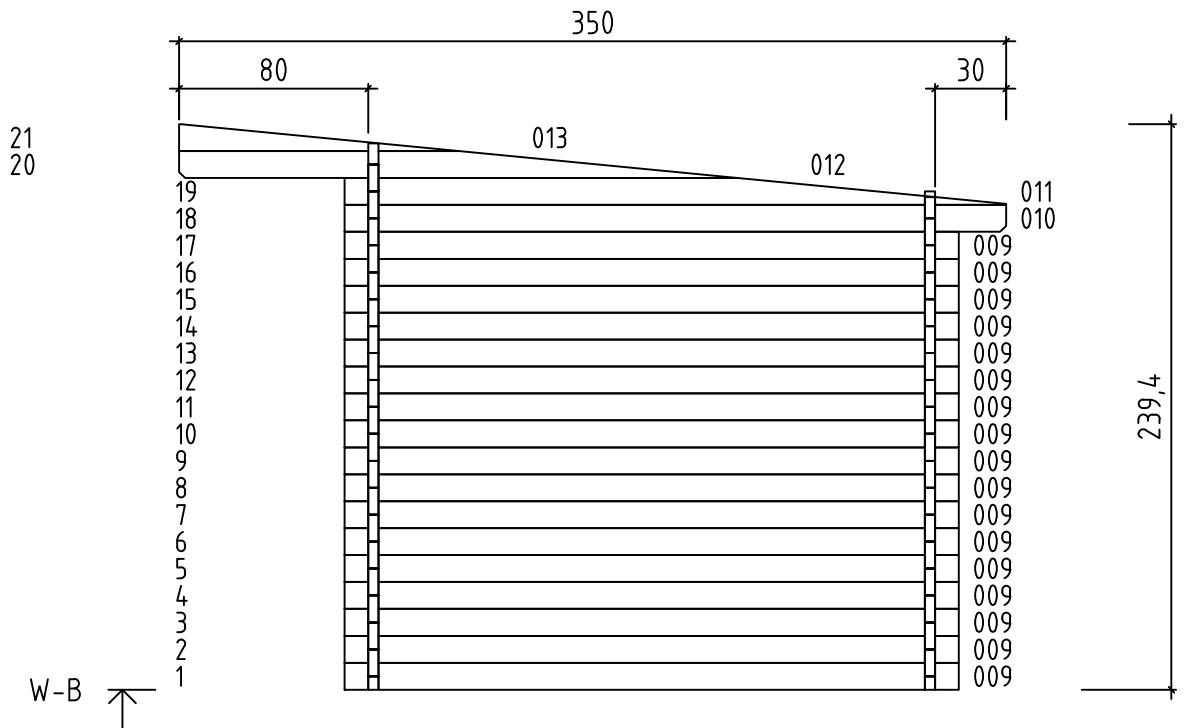
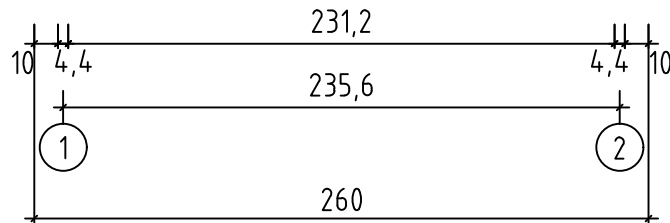
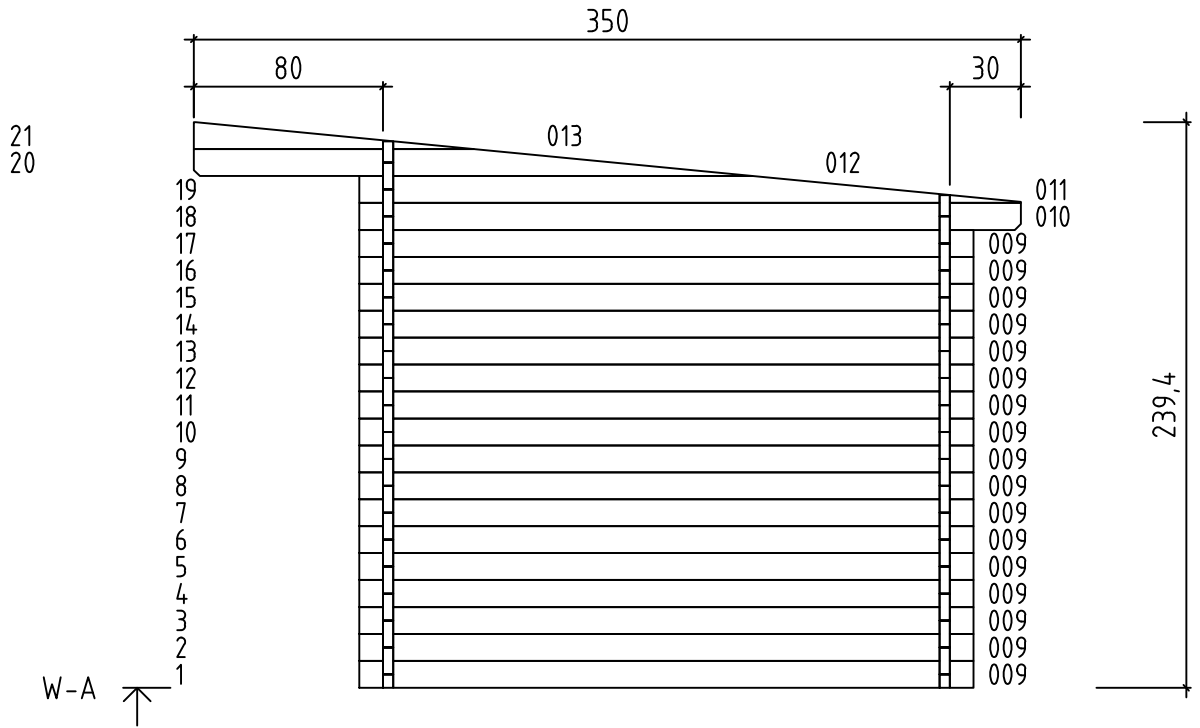

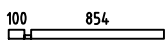
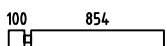

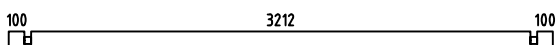
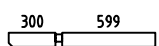

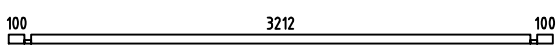
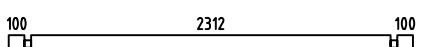
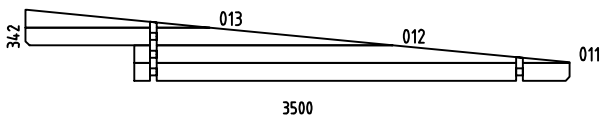

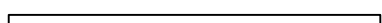
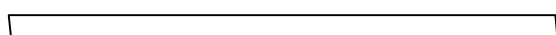
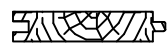
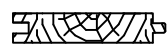



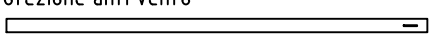

Floor boards - Fussbodenbretter - Plan pose plancher -
Pavimento - Vloerhout - Põrandalaudis

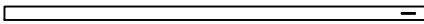
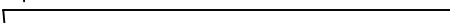
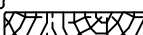
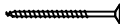
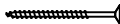
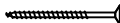
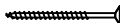
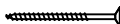
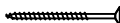
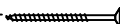





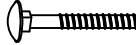



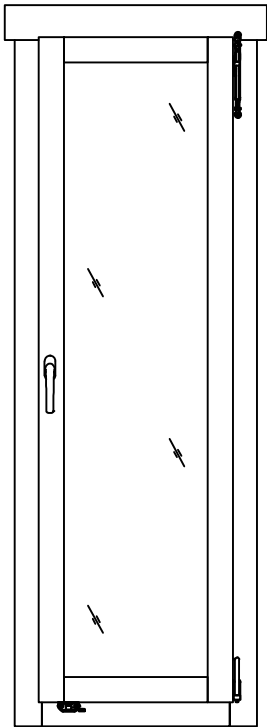
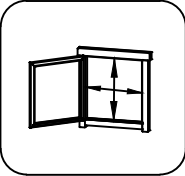



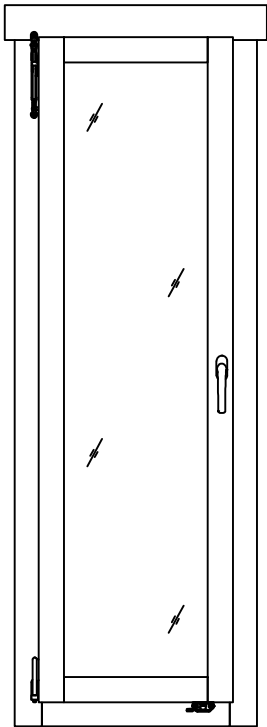
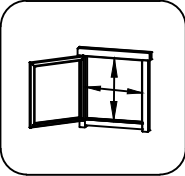

Pos	19.02.2021 Piece list - Stückliste - Liste des pièces - Elementi - Stuklijst - Tükitalabel Art.Nr. 4427240	6/7	Q	P (mm)	L (mm)
001			2	44x57	998
002			2	44x114	998
003			32	44x114	214
004			32	44x114	214
005			19	44x114	3500
006			4	44x90	943
007			6	44x90	612
008			1	44x57	3500
009			34	44x114	2600
WA-1 WB-1			1 1		
	Foundation - Fundament - Fondation - Fondamenta - Fundering - Immutatud alusraam				
IAR2			7	45x70	3200
	Foundation - Fundament - Fondation - Fondamenta - Fundering - Immutatud alusraam				
IAR1			2	45x70	2390
	Rafter - Dachsparren - Chevron - Trave - Dak spar - Sarikas				
SR1			4	44x140	3530
	Floor boards - Fussbodenbretter - Lame de plancher - Pavimento - Vloerhout - Põrandalaud		36	90x18	2308
	Roof boards - Dachbretter - Voliges - Perlina per tetto - Dakhout - Katuselaud		40	90x18	3900
	Floor fillet - Fussbodenleiste - Corniere de finition du plancher - Finitura per pavimento (battisco pa) - Vloerafwerklijs - Põrandaliist			18x18	11.03
	Roofing felt fillet - Dachpappenleiste - Baguette de fixation du feutre bitumeux - Asse per fissaggio guaina bituminosa - Afdeklijs asfaltpapier - Katusepapiiist		2	18x58	3550
	Roofing felt fillet - Dachpappenleiste - Baguette de fixation du feutre bitumeux - Asse per fissaggio guaina bituminosa - Afdeklijs asfaltpapier - Katusepapiiist		1	18x58	3820
DRV-1	Roof edge reinforcement - Dachrandverstärkung - Corniere de renfort de bord de toit - Rinforzo x tetto - Dakrand versterking - Räästafugevdus		2	28x34	300
DRV-2	Roof edge reinforcement - Dachrandverstärkung - Corniere de renfort de bord de toit - Rinforzo x tetto - Dakrand versterking - Räästafugevdus		2	28x34	800
DRV-3	Roof edge reinforcement - Dachrandverstärkung - Corniere de renfort de bord de toit - Rinforzo x tetto - Dakrand versterking - Räästafugevdus		2	28x34	2320
KFS-1	Storm protection - Sturmleiste - Latte anti-tempete - Protezione anti vento - Stormverankering / beveliging - Tormikinnitusliist		2	22x45	2050

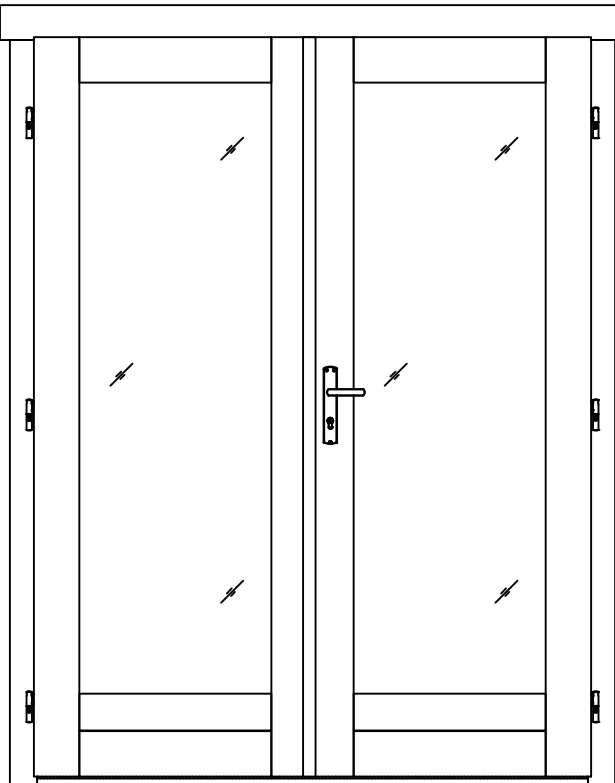
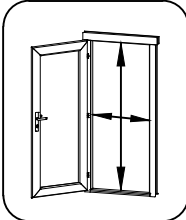
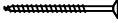
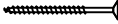
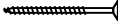
Pos	19.02.2021 Piece list - Stückliste - Liste des pièces - Elementi - Stuklijst - Tükítabel Art.Nr. 4427240	7/7	Q	P (mm)	L (mm)
KFS-2	Storm protection - Sturmleiste - Latte anti-tempete - Protezione anti vento - Stormverankerung / beveiliging - Tormikinnitusliist 		2	22x45	2500
	Gable moulding - Giebelleiste - Planche de rive - Finitura per frontale e retro del tetto - Gevellijst - Viilulaud 		2	18x120	3528
	Gable moulding - Giebelleiste - Planche de rive - Finitura per frontale e retro del tetto - Gevellijst - Viilulaud 		3	18x120	3936
HS9	Screw for gable moulding - Schrauben für giebelleiste - Vis pour fixation planche de rive - Vite per fissare finiture davanti e dietro del tetto - Schroef voor gevellijst - Kruvi viilulauale 		52	3.5x50	
HS12	Screw for roof edge reinforcement - Schrauben für dachrandverstärkung - Vis pour fixation corniere renfort de bord de toit - Viti x rinforzo bordo tetto - Schroef voor dakrand versterking - Kruvi räästatugevdusele 		20	4x40	
HS18	Screw for roof beams - Schrauben für dachbalken - Vis pour fixation pannes de toit - Viti per perline del tetto - Schroef voor gordingen / dakbalken - Kruvi pärlinitele 		12	5x120	
HS18	Screw for gable - Schrauben für giebel - Vis pour fixation des pignons - Viti per timpano - Schroef voor gevelpunt - Kruvi viilude kinnitamiseks 		6	5x120	
HS16	Screw for 1. wall beam - Schraube für 1. bohlenreihe - Vis de fixations 1ere rangée de madriers avec poutrelles de fondations - Vite fissaggio alle fondamenta - Schroef voor 1 wandbalk - Kruvi poollauale 		7	5x90	
HS16	Screw for foundation - Schrauben zur befestigung fundament - Vis de fixations des poutrelles de fondations - Viti x fondamenta - Schroef voor fundering - Kruvi alusraamile 		14	5x90	
HS23	Screw for pos.006 & 007 - Schrauben für pos.006 & 007 - Vis pour pos. 006 & 007 - Viti per fissare elemento vedi figura in pos. n. 006 & 007 - Schroef voor pos. 006 & 007 - Kruvi pos. 006 & 007 		20	6x180	
NF2	Zn nail for floor fillet - Zn nägel für fussbodenleiste - Pointe pour corniere de finition du plancher - Chiodi x fissaggio pavimento - Spijker(nagel) voor vloer afdekljst - Nael põrandaliistule 		23	1.4x40	
SH44	Hammer block - Schlagholz - Calle de frappe - Blocco di legno da usare come cuscinetto quando si usa il martello - Slagklos - Löögiklots 		1		
SFS	Nut for storm protection - Schraubenmutter für sturmleiste - Ecrou pour latte anti-tempete - Dado x asta protezione vento - Moer voor stromverankerung - Mutter tormikinnitusliistule 		8	D8	
NF4	Zn nail for roof - Zn nägel für dachbretter - Pointe pour fixation voliges de toit - Chiodi x perline tetto - Spijker(nagel) voor dakhout - Nael katuselauale 		254	2x50	
NF4	Zn nail for floor - Zn nägel für fussbodenbretter - Clous pour plancher - Chiodi x perline pavimento - Spijker(nagel) voor vloer - Nael põrandalauale 		185	2x50	
NF5	Zn nail for roofing felt fillet - Zn nägel für dachpappenleiste - Pointe pour baguette de fixation feutre bitumeux - Chiodi x carta bituminosa x tetto - Spijker(nagel) voor asfaltpapier afdekljst - Papiliistunael 		27	2x40	
BFS	Bolt for storm protection - Bolzen für sturmleiste - Boulon pour latte anti-tempete - Bullone x asta protezione vento - Bout voor stormankerlat - Puidupolt tormikinnitusliistule 		8	8x80	
DFS	Washer for storm protection - Dichtscheibe für sturmleiste - Rondelle pour latte anti-tempete - Rondella x asta protezione vento - Afdichtring voor storm strip - Seib tormikinnitusliistule 		8	D8	
	Window - Fenster - Fenetre - Finestra - Raam - Aken	560x1780 AK.1.100.TPSP DGP+	1		
	Window - Fenster - Fenetre - Finestra - Raam - Aken	560x1780 AK.1.100.TPSV DGP+	1		
	Door - Tür - Porte - Porte - Deur - Uks	1494x1957 TUK.1.100.TPVP.MMb DGP+	1		

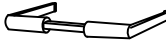
Pos	10.11.2017 Piece list - Stückliste - Liste des pièces - Elementi - Stuklijst - Tükitalabel 560x1780 AK.1.100.TPSP DGP+	1/1	Q	P (mm)	L (mm)
	<p data-bbox="256 152 1289 181">Glass size - Glasgröße - Taille de la vitre - Misura del vetro - Glas afmeting - Klaasi mõõt: 390x1602 mm</p>   <p data-bbox="1362 349 1497 378">460x1684 mm</p>				
FS2	<p data-bbox="261 2130 1023 2186">Window handle fittings - Fenstergriff - Poignee de fenetre - Maniglia c/ferramenta - Raamhendel -/grendel -/klink - Aknalink</p>		1		

Pos	10.11.2017 Piece list - Stückliste - Liste des pièces - Elementi - Stuklijst - Tükítabel 560x1780 AK.1.100.TPSV DGP+	1/1	Q	P (mm)	L (mm)
	<p data-bbox="255 152 1289 183">Glass size - Glasgröße - Taille de la vitre - Misura del vetro - Glas afmeting - Klaasi mõõt: 390x1602 mm</p>   <p data-bbox="1364 347 1497 376">460x1684 mm</p>				
FS2	<p data-bbox="255 2132 1021 2190">Window handle fittings - Fenstergriff - Poignée de fenetre - Maniglia c/ferramenta - Raamhendel -/grendel -/klink - Aknalink</p>		1		

Pos	10.11.2017	Piece list - Stückliste - Liste des pièces - Elementi - Stuklijst - Tükitalabel 1494x1957 TUK.1.100.TPVP.MMb DGP+	1/1	Q	P (mm)	L (mm)
		<p>Glass size - Glasgröße - Taille de la vitre - Misura del vetro - Glas afmeting - Klaasi mõõt: 514x1593 mm</p>   <p>1394x1873 mm</p>				
HS4	Screw for door fillet - Schraube zur Befestigung türleiste - Vis pour fixation baguette d'arret de porte - Viti per massellino della porta - Schroef voor deurlijst - Kruvi ukse kokkuvaltšiliistule		5	3x30		
HS16	Screw for door jamb - Schraube für Türrahmen - Vis de fixation partie haute avec montants du cadre de porte - Viti x fissaggio montanti porte - Schroef voor deurkozijn - Kruvi ukse lengile		4	5x90		
HS25	Screw for doorstep - Schrauben für swelle - Vis pour fixation barre de seuil - Vite per soglia della porta - Schroef voor deurdorpel - Kruvi lävepakule		3	4.5x65		
MH	Male bolt hinge for door - Türband - Partie male de paumelle de porte - Cerniera anube x porta - Scharnier bout - Reguleeritav polthing isane		6	14x80		
HC	Covers for door hinges - Schutzkappe für Türband - Couverture de paumelle de porte - Copertura delle cerniere della porta - Afdek kap voor deurscharnier - Reguleeritava polthinge kate		12			
TL4	Door handle fittings - Türgriff - Poignée de porte - Maniglie - Deurhendel / klink - Ukse käepide		1			
TL5	Set of door lock covers - Schlossblenden - Set de garnitures de porte - Copertura serrature - Slot sluitplaat set - Ukse lukuplaat		1			
	Cylinder lock - Zylinderschloss - Barillet de porte - Serratura - Cylinder slot - Ukse lukusüdamik		1	30x35		
	Striker for barrel bolt - Hülse für Grendelriegel - Gache au sol du targette - Boccola per fermo della porta - Huls voor vergrendelingsschuif - Vasturaud ukse servariivile		2			